



OPERATOR'S MANUAL **INTERNATIONAL®** **CUB CADET®** **72, 104, 105,** **124 and 125** **Tractors**

OPERATION
MAINTENANCE
LUBRICATION



To The Owner

Assembled in this manual are operation, lubrication, and maintenance instructions for the International Cub Cadet 72, 104, 105, 124 and 125 Tractors. This material has been prepared in detail to help you better understand the correct care and efficient operation of your tractor. Before you operate the tractor, study this manual carefully. New copies may be ordered from your dealer at a nominal price.

Your local International Harvester dealer is interested in the performance you receive from this tractor. He has factory-trained servicemen, informed in the latest method of servicing tractors, and modern tools, and original-equipment IH service parts which assure proper fit and good performance.

The International Cub Cadet 105 and 125 Tractors have a hydrostatic drive. It is the

best hydraulic drive unit available and will require minimum service if recommended operating and maintenance procedures are followed. Should you have difficulties with the unit consult your International Harvester dealer. **UNDER NO CIRCUMSTANCES SHOULD YOU ATTEMPT TO SERVICE THESE UNITS YOURSELF.** Only your dealer is authorized to repair or replace units on this drive under the terms of the warranty. Should you desire additional information not found in this manual, contact your International Harvester dealer.

The International Cub Cadet 72, 104 and 124 Tractors have a conventional clutch and transmission.

To obtain top performance and assure economical operation the tractor should be inspected, depending on its use, periodically, or at least once a year, by your International Harvester Dealer.

When in need of parts, always specify the tractor and engine serial numbers, including the prefix and suffix letters. Write these serial numbers in the spaces provided below.

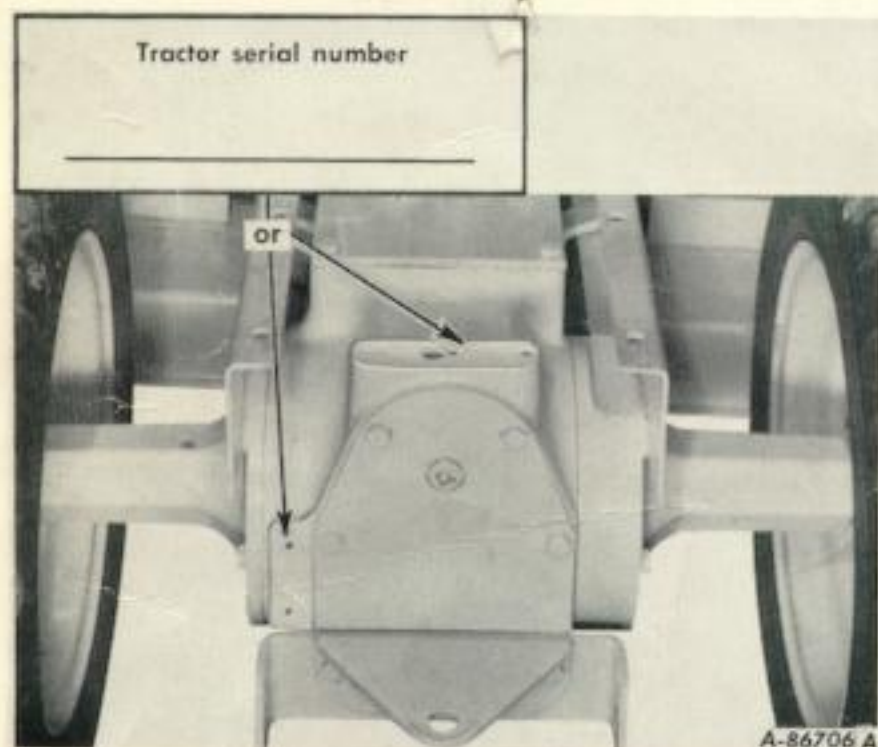

INTRODUCTION



Terms of location.

A variety of extra equipment and accessories is available. Where operating and maintaining instruction is required, it is included in the instruction for operating and maintaining the tractor. Disregard the instructions for equipment not on your tractor.

The illustrations in this manual are numbered to correspond with the pages on which they appear; for example, Illust. 1 on page 1.

LEFT and RIGHT indicate the left and right sides of the tractor when facing forward in the driver's seat. Reference to FRONT indicates the grille end of the tractor; to REAR, the drawbar end.

INTRODUCTION



A-90100

Illust. 1
International Cub Cadet 124 Tractor.



A-90101

Illust. 1A
International Cub Cadet 105 Tractor.
1

INTRODUCTION

Assembled in this manual are operation, application, and maintenance instructions for the International Cub-Cadet and 145 Tractors. The manual is intended to help you get the most out of your tractor. Before you operate your tractor, please read this manual carefully. It contains important information that will help you avoid accidents and keep your tractor in good working order.

Your safety is our first concern. Please read this manual carefully. It contains important information that will help you avoid accidents and keep your tractor in good working order. The International Tractors have a reputation for reliability and safety.



A-90102

Illust. 2
International Cub Cadet 104 Tractor.



A-90103

Illust. 2A
International Cub Cadet 72 Tractor.

Baldwin Inc.
684-3364

CONTENTS

Description	Page No.
INTRODUCTION	Inside cover, 1, 2
CONTENTS	3
INSTRUMENTS AND CONTROLS	3, 4, 5, 6
BEFORE OPERATING YOUR NEW TRACTOR	7
OPERATING THE ENGINE	7, 8
FUEL SYSTEM	8, 9
DRIVING THE TRACTOR	10, 11, 12
HITCHING TRAILING EQUIPMENT TO THE TRACTOR	12, 13
REAR POWER TAKE-OFF	14
FRONT POWER TAKE-OFF	15
ENGINE COOLING AND AIR CLEANER	16
ELECTRICAL SYSTEM	16 to 21
FRONT WHEELS	22
PNEUMATIC TIRES	22, 23
CLUTCH AND BRAKE	23, 24, 25
STORING THE TRACTOR	26
EXTRA EQUIPMENT AND ACCESSORIES	26
TROUBLE SHOOTING	27, 28
LUBRICATION	28, 29
LUBRICATION TABLE	29
LUBRICATION GUIDE	30 to 34
SPECIFICATIONS	34 to 36
INDEX	37

INSTRUMENTS AND CONTROLS

Your Cub Cadet Tractor has been safety engineered. Thoroughly acquaint yourself with all the instruments and controls before attempting to start or operate the tractor.

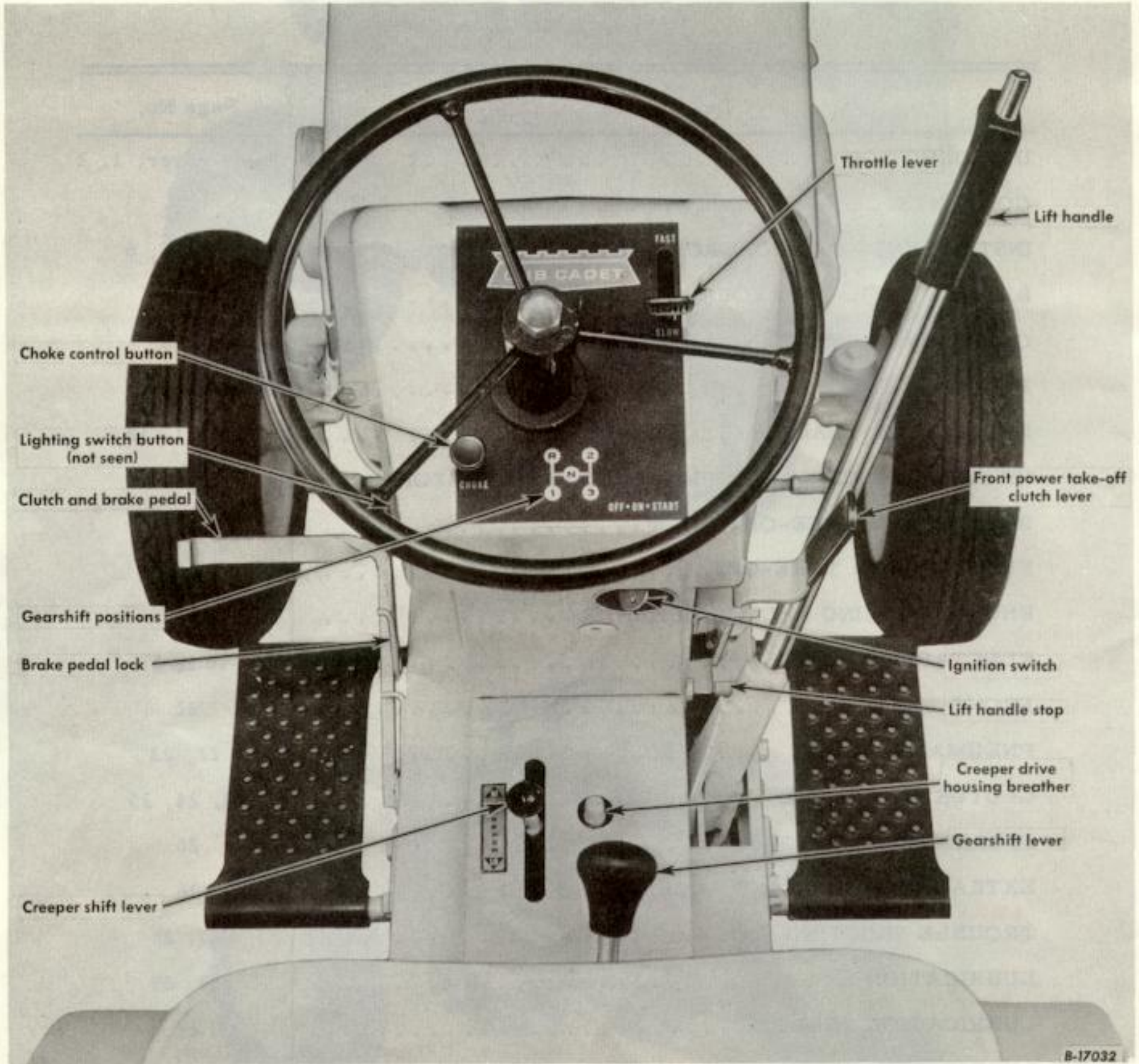

Illust. 4

Instruments and controls on the International Cub Cadet 72 Tractor.

Page references for items shown in Illust. 4.

Brake pedal lock	See pages 10 and 11.	Ignition switch	See page 16.
Choke control button	See page 8.	Lift handle	See page 13.
Clutch and brake pedal	See pages 23 and 24.	Lift handle stop	See page 13.
Creeper shift lever	See page 11.	Lighting switch button	See pages 16 and 19.
Front power take-off clutch lever	See page 15.	Throttle lever	See page 7.
Gearshift lever	See page 11.		

BEFORE OPERATING INSTRUMENTS AND CONTROLS TRACTOR

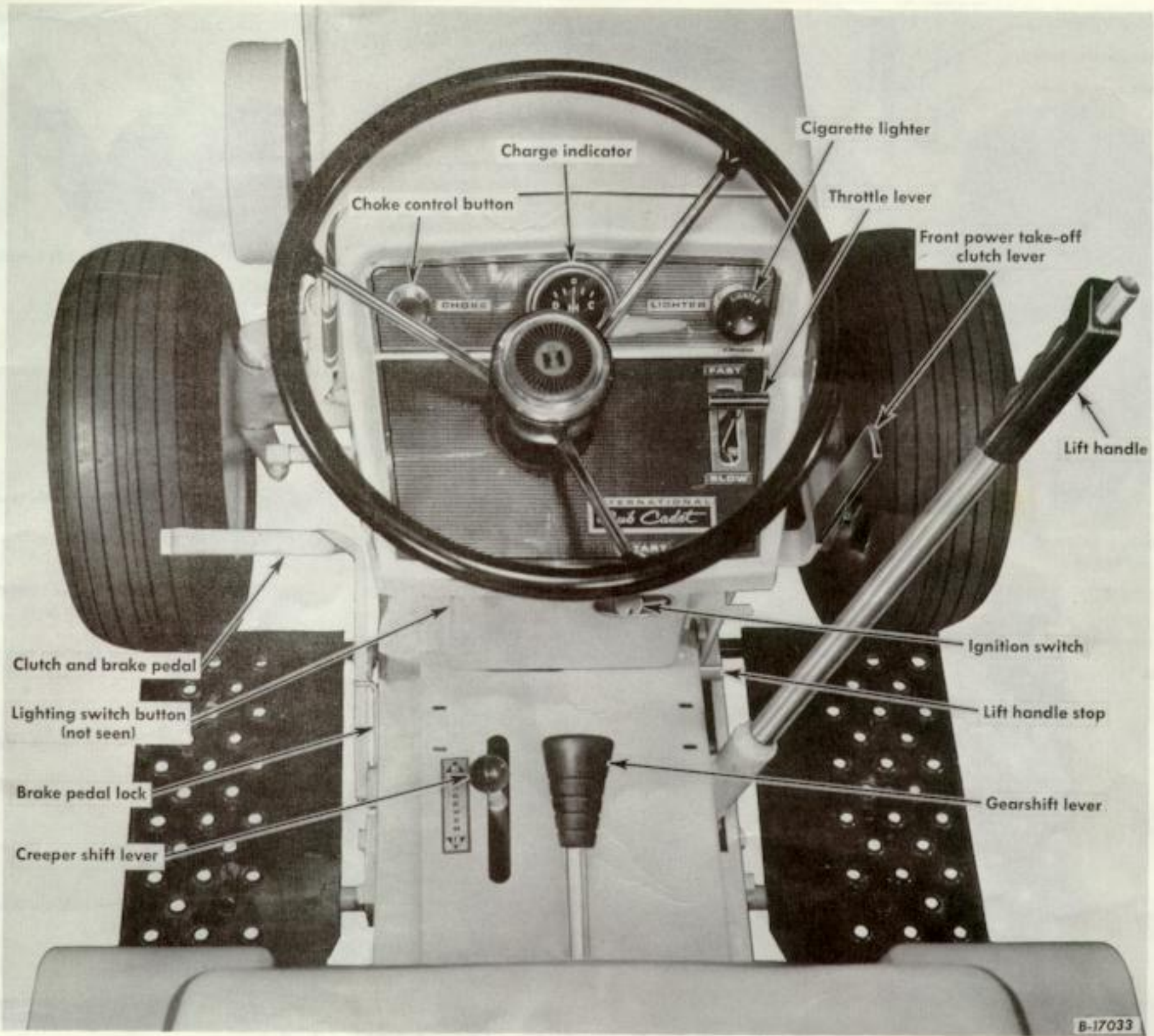

Illustr. 5
Instruments and controls on the International Cub Cadet 104 and 124 Tractors.

Page references for items shown in Illustr. 5.

Brake pedal lock	See pages 10 and 11.
Charge indicator	See page 16.
Choke control button	See page 8.
Cigarette lighter	See page 17.
Clutch and brake pedal	See pages 23 and 24.
Creeper shift lever	See page 11.
Front power take-off clutch lever	See page 15.
Gearshift lever	See page 11.
Ignition switch	See page 17.
Lift handle	See page 13.
Lift handle stop	See page 13.
Lighting switch button	See pages 16 and 19.
Throttle lever	See page 7.

INSTRUMENTS AND CONTROLS

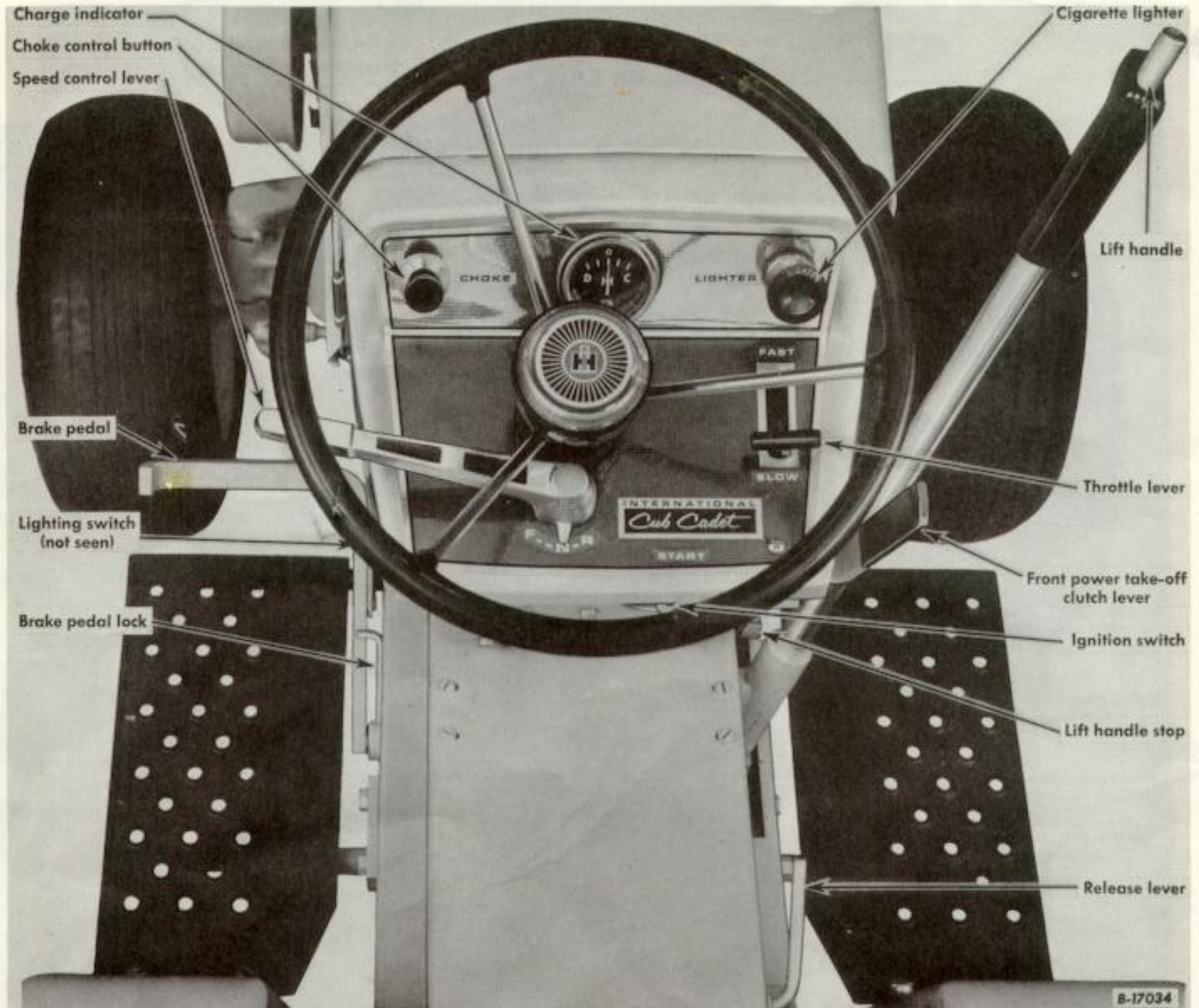

Illust. 6
Instruments and controls.
(International Cub Cadet 105 and 125 Tractors)

Page references for items shown in Illust. 6.

Brake pedal	See page 25.
Brake pedal lock	See pages 10 and 12.
Charge indicator	See page 16.
Choke control button	See page 8.
Cigarette lighter	See page 17.
Front power take-off clutch lever	See page 15.
Ignition switch	See page 16.
Lift handle	See page 13.
Lift handle stop	See page 13.
Lighting switch button	See pages 17 and 19A.
Speed control lever	See page 12.
Throttle lever	See page 7.
Release lever	See page 12.

BEFORE OPERATING YOUR NEW TRACTOR

Lubrication Lubricate the entire tractor. See pages 28 to 34.

Tires Check the air pressure. See pages 22 and 23.

Fuel system Fill the fuel tank with gasoline. See page 8.

OPERATING THE ENGINE

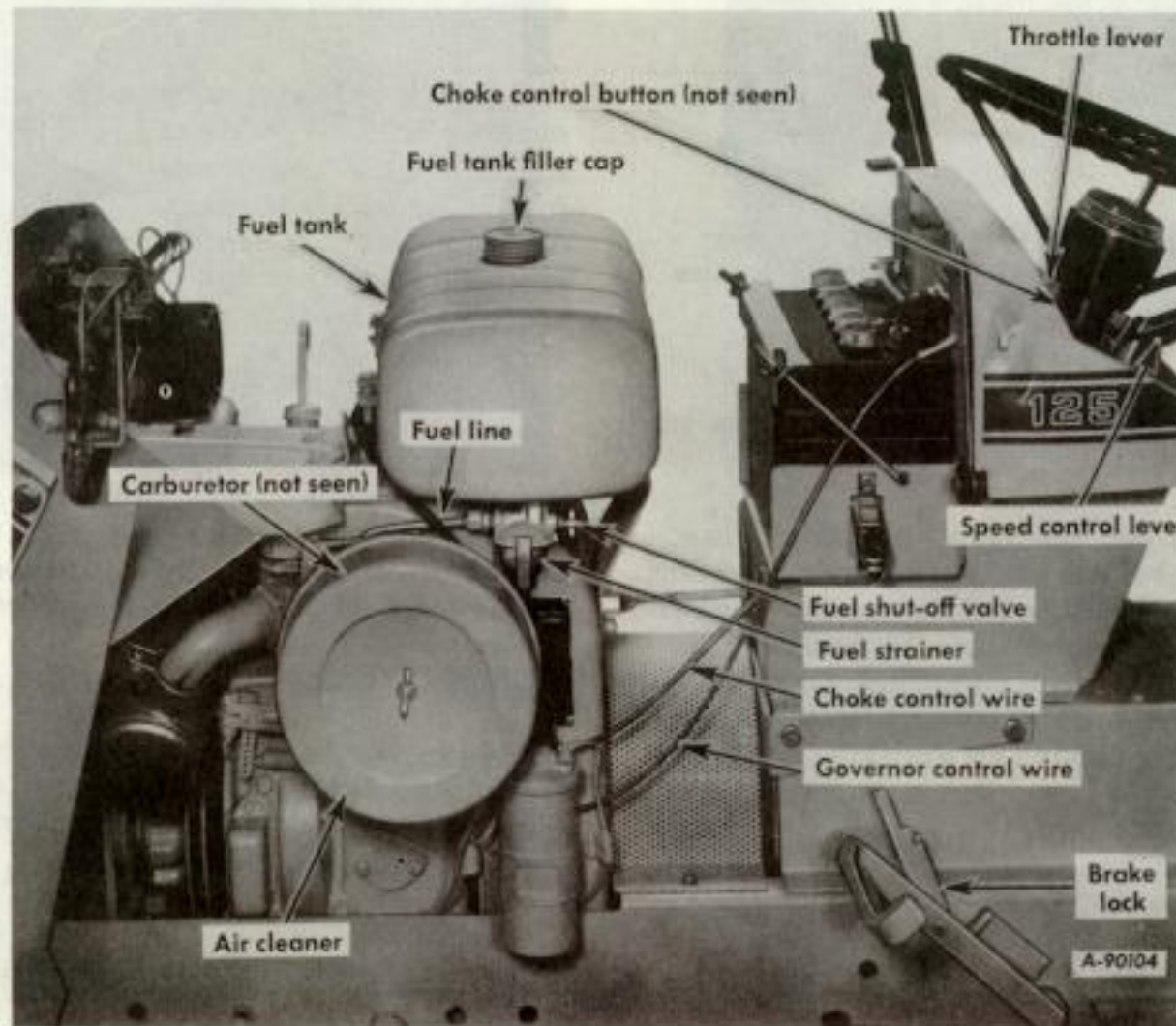

Illust. 7
Fuel system and controls on International Cub Cadet 125 Tractor.
(International Cub Cadet 72, 104, 105 and 124 Tractors are similar.)

THROTTLE LEVER

This lever controls the speed of the engine. When set in a given position, it will maintain a uniform engine speed.

GOVERNOR

The governor is set at the time the engine is assembled and should not require readjustment unless the governor arm is removed or loosened from the governor shaft. Consult your International Harvester dealer if the governor does not function properly.

LIFTING THE HOOD

The tractor hood is arranged to swing up and forward to make the engine and fuel tank readily accessible. To raise the hood on the International Cub Cadet 72 Tractor, take hold of each side of the hood at the rear, pull outward, and raise it upward and forward to its stop. On the International Cub Cadet 104, 105, 124 and 125 Tractors unlatch the hood latches located at the rear of the hood and follow the same procedure of the International Cub Cadet 72 Tractor.

OPERATING THE ENGINE

STARTING THE ENGINE

1. Be sure the fuel shut-off valve is open.
2. Pull the choke control button all the way out (see *Illust. 4 or 5*). More or less choking may be necessary due to variations in temperature, grade of fuel, etc. Little or none will be needed when the engine is warm.

3. Place the throttle lever halfway between "SLOW" and "FAST". See *Illust. 4 or 5*.

4. **Electric Starting:** The engine cannot be started unless the brake pedal is pressed all the way down to activate the safety starting switch.

International Cub Cadet 72, 104, and 124 Tractors: Check to see that the gearshift lever is in the neutral position. See *Illust. 4*.

International Cub Cadet 105 and 125 Tractors: Check to see that the speed control lever is in the "N" positions. See *Illust. 6*.

All Models: Turn the ignition key clockwise to the "START" position and release it as soon as the engine starts; however do not operate the motor-generator for more than 30 seconds at any one time. If the engine does not start within this time, turn the key "OFF" and wait a few minutes, then try again.

5. After the engine starts, slowly release the brake pedal and gradually push the choke

control button all the way in. Do not use the choke to enrich the fuel mixture, except when necessary to start the engine.

Manual Starting (Tractors without electric starting):

Raise the tractor hood. The retractable starter is mounted on a support plate at the front of the engine at the right side of the tractor.

Put the gearshift lever in the neutral position and lock the brake. Turn the key ignition switch clockwise.

Give a quick steady pull on the retractable starter handle to start the engine. Do not jerk, or pull it out to its very end in a rough manner. A steady pull will accomplish just as much. Always pull the handle so the cord is in a straight line through the guide. Maintain your hold on the handle and allow the cord to return slowly. Releasing the handle when the cable is extended will shorten the life of the starter.

5. After the engine starts, slowly release the clutch pedal and gradually push the choke control button all the way in. Do not use the choke to enrich the fuel mixture, except when necessary to start the engine.

STOPPING THE ENGINE

Move the throttle lever to the "SLOW" position and allow the engine to idle for a short time before stopping. Then turn the key to the "OFF" position.

FUEL SYSTEM

FUEL SYSTEM

Fill the fuel tank with clean, fresh, regular grade gasoline, preferably at the end of each day's use. This will force out any moisture-laden air and prevent condensation in the fuel tank. Do not mix oil with the gasoline.

The fuel tank filler cap has an air vent. Keep the vent open at all times to assure proper flow of the fuel.

Caution! Never remove the fuel tank cap or fill the fuel tank when the engine is running, is hot, or when near an open flame. Do not smoke when working around inflammable fuel, as the air around the tractor is mixed with a highly explosive vapor. When pouring fuel, keep the container or hose nozzle in contact with the metal of the fuel tank to avoid the possibility of an electric spark igniting the gas. Do not spill gasoline on a hot engine.

FUEL SHUT-OFF VALVE

Be sure the shut-off valve on the fuel strainer under the gasoline tank is open. Screw out the needle stem (Shut-off valve) until the seat on the stem is tight against the stop, to prevent leakage or seepage when the valve is in its full-open position.

CLEANING THE FUEL STRAINER AND SEDIMENT BOWL

After every 25 hours of operation, clean the fuel strainer as follows:

1. Close the shut-off valve. See *Illusts. 9 and 9A*. Loosen the knurled nut under the sediment bowl and remove the bowl and screen.
2. Clean the sediment bowl and screen.
3. When reassembling, be sure the gasket between the bowl and the main body is in good condition and does not leak. Use a new gasket if necessary.

FUEL SYSTEM



Illust. 9
Carburetor and fuel strainer.
(International Cub Cadet 72 Tractor)

CARBURETOR ADJUSTMENTS

The carburetor is adjusted at the factory and under normal operating conditions it will not require readjusting. If this adjustment has been disturbed for any reason, proceed as follows:

Adjusting the High-Speed Adjustment Screw

Turn the high speed adjustment screw (Illusts. 9 and 9A) counter-clockwise approximately two turns from the closed position and start the engine.

After the engine has reached normal operating temperature, accelerate the engine and check its response.

Place the engine under load and turn the high speed adjustment screw (Illusts. 9 and 9A) to the leanest mixture that will allow satisfactory acceleration and steady governor operation.

If the engine misses and backfires under load, the high speed mixture is too lean. The high speed adjustment screw must be turned counter-clockwise 1/4 turn at a time until the condition is corrected.

If the engine shows a sooty exhaust and is sluggish under load, the high speed mixture is too rich. The high speed adjustment screw must be turned clockwise 1/4 turn at a time until the condition is corrected.



Illust. 9A
Carburetor and fuel strainer.
(International Cub Cadet 104, 105, 124 and 125 Tractors)

For a final check of the high speed adjustment, operate the engine under load and make any corrections necessary for smooth operation.

Adjusting the Idle Adjustment Screw

After the high speed adjustment screw is adjusted, it may be necessary to readjust the idle adjustment screw (Illusts. 9 and 9A), as each affects the other.

Close the idle adjustment screw to its seat by turning it clockwise; then open it one turn. Start the engine and operate it at fast idling speed (without any load) until thoroughly warm.

While the engine is running at fast idle speed, it is advisable to screw in the throttle stop screw (Illusts. 9 and 9A) a few turns to keep the engine from stopping when the throttle lever is moved to the fully retarded "SLOW" position. The engine will then be idling at a fairly high speed and the throttle stop screw can be backed out a little at a time until the desired idle speed is obtained.

If the engine misses or rolls while backing out the throttle stop screw, the idle adjustment screw may be adjusted in or out until the engine operates smoothly. Speed up the engine for a few seconds; then recheck the idle adjustment. A slight adjustment in or out will give the smoothest idle.

DRIVING THE TRACTOR

PREPARING THE TRACTOR FOR EACH DAY'S WORK

Fill the fuel tank at the end of each day's run. See page 8.

Check the crankcase oil level and add new oil if necessary. See page 28.

Clean the air cleaner element if necessary. See page 16.

Inspect the tires for general condition. See pages 22 and 23.

ADJUSTING THE SEAT

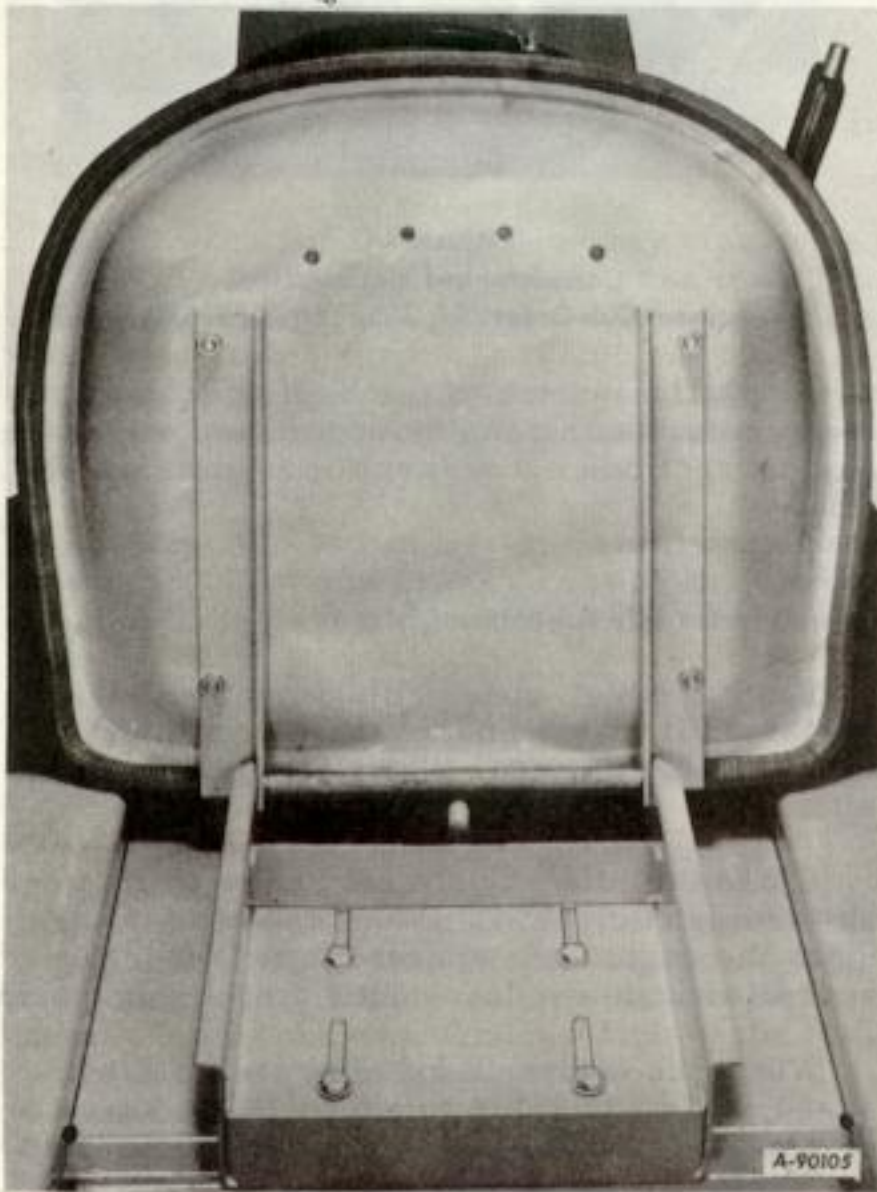

Illust. 10
Adjusting the seat.
(International Cub Cadet 104, 105, 124 and 125 Tractors)

Before starting the tractor, adjust the seat to the most comfortable driving position by loosening the four cap screws in the seat support (Illust. 10) or seat spring clamping plate (Illust. 10A) and sliding the seat assembly forward or rearward to the position which is most comfortable for the operator.

Retighten the cap screws after the seat is adjusted.

The International Cub Cadet 104, 105, 124 and 125 Tractors features a seat which can be tilted forward over the steering wheel, for convenience in adjusting the seat and to keep out rain and snow. See Illust. 10.

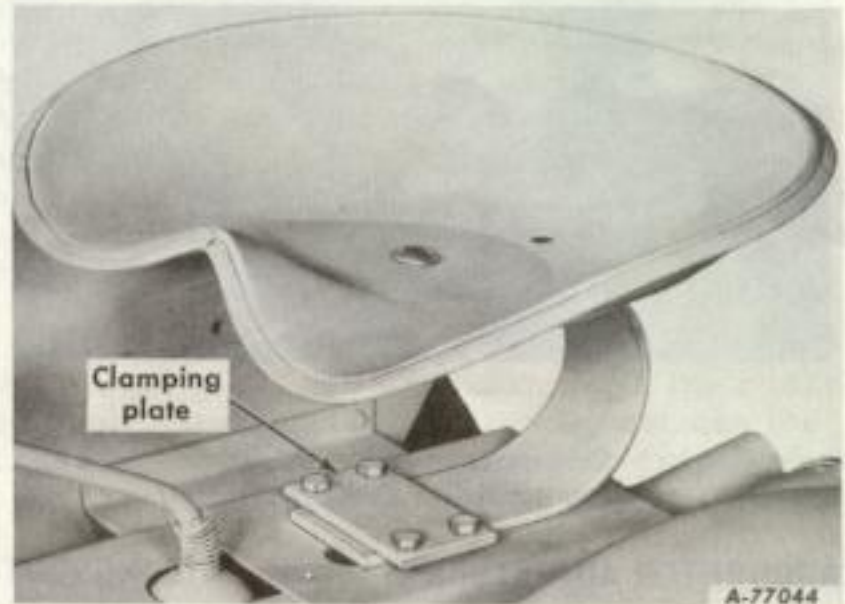

Illust. 10A
Adjusting the seat.
(International Cub Cadet 72 Tractor.)

CLUTCH AND BRAKE PEDAL

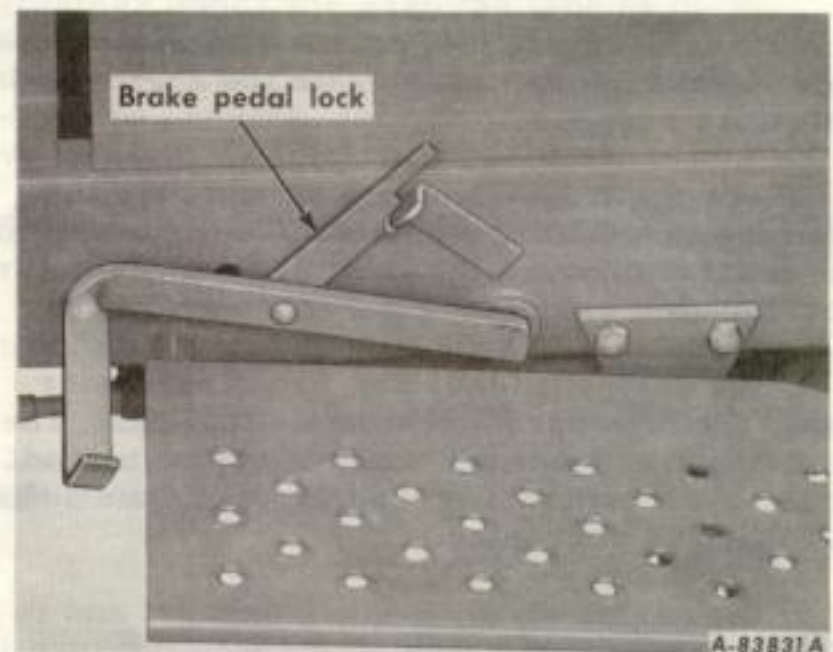

Illust. 10B
Brake pedal lock in the engaged position.

DRIVING THE TRACTOR

(International Cub Cadet 72, 104 and 124 Tractors)

CLUTCH AND BRAKE PEDAL - Continued

The combination clutch and brake pedal is used to disengage the engine from the transmission when shifting gears and to actuate the brake to stop the tractor. The pedal must be pressed all the way down to activate the safety starting switch when starting the engine.

To disengage the clutch, press the pedal approximately half way down. To stop the tractor press the pedal all the way down.

LOCKING THE BRAKE

Always lock the brake when the tractor is parked on a grade. To lock the brake, press down on the brake pedal; then place the brake pedal lock in the engaged position. To disengage the lock, press down on the brake pedal lift the lock up and place it in the disengaged position behind the brake pedal as shown in *Illust. 7*.

GEARSHIFT LEVER

This lever is used to select various gear ratios provided in the transmission. There are three forward speeds and one reverse speed. See *Illust. 4*. Refer to "SPECIFICATIONS" on page 34.

STARTING THE TRACTOR

1. Advance the throttle lever slightly. See *Illust. 4*.

2. Disengage the clutch by pressing the clutch pedal all the way down, and move the gearshift lever to the desired speed.

3. Start the tractor in motion by slowly releasing the clutch pedal and moving the throttle lever to the position where the engine operates best for the load to be handled.

Note: Do not shift gears while the engine clutch is engaged or while the tractor is in motion.

Note: Do not rest your foot on the pedal while driving the tractor, as this will result in excessive clutch lining wear.

Always be sure the rear wheels are free to turn. Under any adverse conditions, do not attempt to free the tractor by speeding up the engine and suddenly engaging the clutch. Try backing out instead of going forward.

STOPPING THE TRACTOR

Disengage the clutch by pressing the pedal all the way down. Move the gearshift lever to the neutral position.

CREEPER SHIFT LEVER

The creeper drive provides a slower speed in each respective gear, by a four-to-one reduction in speed from direct drive. When the creeper shift lever is all the way forward, it is in direct drive, or all the way rearward, it is in creeper drive. See *Illust. 4*. **Note:** Do not use a mid-point position on the creeper drive as neutral. Neutral position must be selected only with the standard transmission gearshift lever.

OPERATING THE CREEPER DRIVE

To operate the tractor in creeper drive, move the creeper shift lever (*Illust. 4*) all the way rearward. Then select the speed desired and proceed as instructed under "Starting the Tractor".

The following table shows the speeds available in each of the three forward gears and the reverse gear.

SPEED TABLE

Gear	Miles Per Hour	
	Direct Drive	Creeper Drive
First	2.3	.6
Second	3.9	1.0
Third	6.8	1.7
Reverse	2.5	.6

DRIVING THE TRACTOR (International Cub Cadet 105 and 125 Tractors)

BRAKE PEDAL

The brake pedal must be pressed all the way down to activate the safety starting switch. When the brake pedal is in the depressed position it automatically moves the speed control lever to the "N" position.

The tractor can be stopped either by pressing the pedal all the way down, or placing the speed control lever in the "N" position.

LOCKING THE BRAKE

Always lock the brake when dismounting from the tractor. To lock the brake, press down on the brake pedal; then place the brake pedal lock in the engaged position. See *Illust. 10B*. To disengage the lock, press down on the brake pedal, lift the lock up and place it in the disengaged position behind the brake pedal as shown in *Illust. 7*.

SPEED CONTROL LEVER

This lever is used to select any speeds from a standstill "N" position to eight miles per hour in the forward direction and to four miles per hour in the reverse direction.

Moving the speed control lever forward provides increased forward speeds, and moving the lever rearward provides the reversed speeds.

Note: Do not rest your foot on the brake pedal while driving the tractor as this would cause the speed control lever to return to the "N" position.

Note: On tractors with a rotary tiller the following instructions are required.

1. Engage the Power Take-Off clutch.
2. Lower the rotary tiller to the desired cutting depth.
3. Move the speed control lever to start forward motion. **Note:** In rotary tilling application,

the tractor is used to hold the rotary tiller back rather than to pull the unit, as in plowing or mowing.

4. Move the speed control lever back to a position to maintain proper mulching of the soil.

5. With a hydrostatic drive, it may be necessary to vary the speed control lever as the soil conditions vary. With a gear drive tractor, under similar conditions, it may be necessary to declutch or to use the brake.

6. If desired depth cannot be obtained in the first pass, additional passes will be necessary. Do not use tine extensions when attempting deep penetration or when tilling heavy soil.

STARTING THE TRACTOR

1. Advance the throttle lever slightly. See *Illust. 6*.
2. Depress the brake pedal by pressing the pedal all the way down, and move the towing lever (*Illust. 6*) in drive (horizontal) position, then move the throttle lever to the position where the engine operates best for the load to be handled.
3. Start the tractor in motion by moving the speed control lever forward or rearward as described above.

RELEASE LEVER

To push or move tractor for a short distance or when working on the engine, the release lever (*Illust. 6*) must be locked in the release (down) position and the speed control lever must be in the "N" position. **Caution: Do Not Tow.**

STOPPING THE TRACTOR

Move the speed control lever to the "N" position or use the brake. Before dismounting always depress the brake pedal.

HITCHING TRAILING EQUIPMENT TO THE TRACTOR

Trailing-type equipment must be hitched to the tractor only at the hitch hole in the drawbar. See *Illusts. 13 and 13A*.

When the tractor has a three-point hitch (*Illusts. 13 and 13A*) equipment adaptable to the

three-point hitch is raised and lowered with the lift handle. The lift handle can be set to hold the equipment at various positions by use of the six notches in the lift handle quadrant. The lower mounting bracket has three holes which are used for additional adjustment.

HITCHING TRAILING EQUIPMENT TO THE TRACTOR

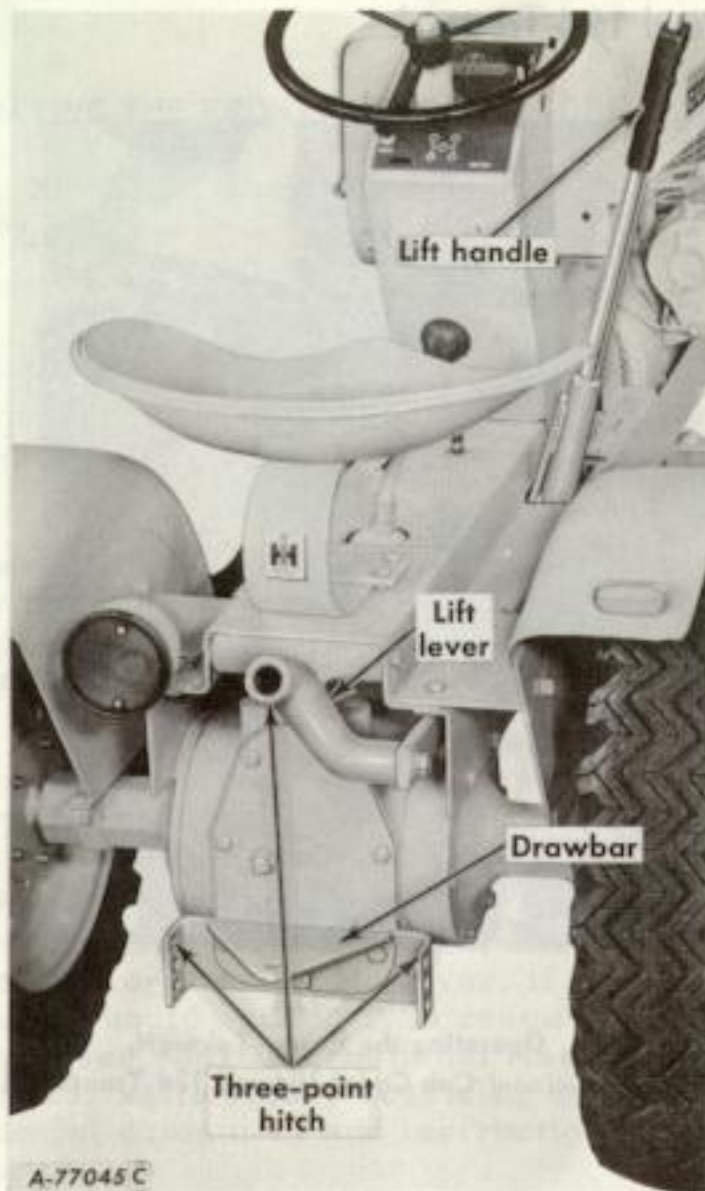

Illustr. 13

Drawbar and three-point hitch shown on International Cub Cadet 72 Tractor.



Illustr. 13A

Drawbar and three-point hitch.
(International Cub Cadet 104, 105, 124 and 125 Tractors)

LIFT HANDLE



Illustr. 13B

Adjustable stop limiting handle travel.

This handle is used to lift or lower equipment used with the tractor. Depress the release button to move the handle.

When operating equipment in the "FLOAT" position, depress the release button on top of the handle, and also press in the lock button located at the front of the handle. See Illustr. 13B.

Note: To disengage the lift handle from the float position, pull lift handle lock slightly and depress top button.

When the equipment is allowed to float, the position of the lift handle forward travel can be limited by the adjustable stop. Loosen the nut, slide the stop to the required position, and tighten the nut. See Illustr. 13B.

Refer to the equipment manual for proper hitching instructions.

FRONT QUICK ATTACHING LATCH

This latch (Illustr. 22) is used for front and center mounted equipment. Refer to the equipment manual for proper instructions.

REAR POWER TAKE-OFF

(International Cub Cadet 72, 104 and 124 Tractors)



Illust. 14

Operating the Power Take-off.
International Cub Cadet 72 Tractor



Illust. 14A

Operating the Power Take-off.
International Cub Cadet 104 and 124 Tractors

If your tractor is equipped with a rear power take-off, the following instructions and precautions should be carefully studied and followed.

The rear power take-off is started and stopped by the same engine clutch as the tractor. Be sure to disengage the engine clutch before moving the power take-off shift rod (Illust. 14), or shifter lever (Illust. 14A). The shifter rod should always be in the disengaged (forward) position and the shifter lever in the disengaged (rearward) position when the power take-off is not in use.

Caution! Always cover the power take-off exposed shaft with the guard when the power take-off is not being used.

OPERATING THE REAR POWER TAKE-OFF WITH THE TRACTOR STANDING STILL

1. The transmission gearshift lever must be in the neutral position.

2. Move the throttle lever back to low idle speed.

3. Depress the clutch pedal to disengage the engine clutch.

4. On the International Cub Cadet 72 Tractor; Press down on the shifter rod (Illust. 14) and move it rearward to the engaged position. Then release the shifter rod and allow it to lock in place.

On the International Cub Cadet 104 and 124 Tractors; move the shifter lever (Illust. 14A) forward to the engaged position.

5. Slowly release the clutch pedal.

OPERATING THE REAR POWER TAKE-OFF WITH TRACTOR IN MOTION

Follow the first four steps outlined above; then engage the power take-off shifter rod or lever. Keep your foot pressed down on the clutch pedal (in the disengaged position), advance the throttle lever and move the transmission gear-shift lever to the speed that is desired to run the tractor. Slowly release the clutch pedal. This will start the tractor in motion with the power take-off in operation.

FRONT POWER TAKE-OFF

OPERATING THE FRONT POWER TAKE-OFF CLUTCH

1. Move the throttle lever back to medium or low idle speed.

2. Move the front power take-off clutch lever (forward) to the engaged position (rearward) to the disengaged position. See **Illusts. 4 or 5 and 15A.**

Note: It is recommended that the clutch lever be placed in the forward or engaged position when the tractor is being used without front power take-off equipment.

ADJUSTING THE CLUTCH

The clutch is factory adjusted and should not require further adjustment under normal operating conditions. However, if clutch slippage should occur. It is recommended that you see your International Harvester dealer for satisfactory servicing of the clutch, as special equipment and instructions are required.

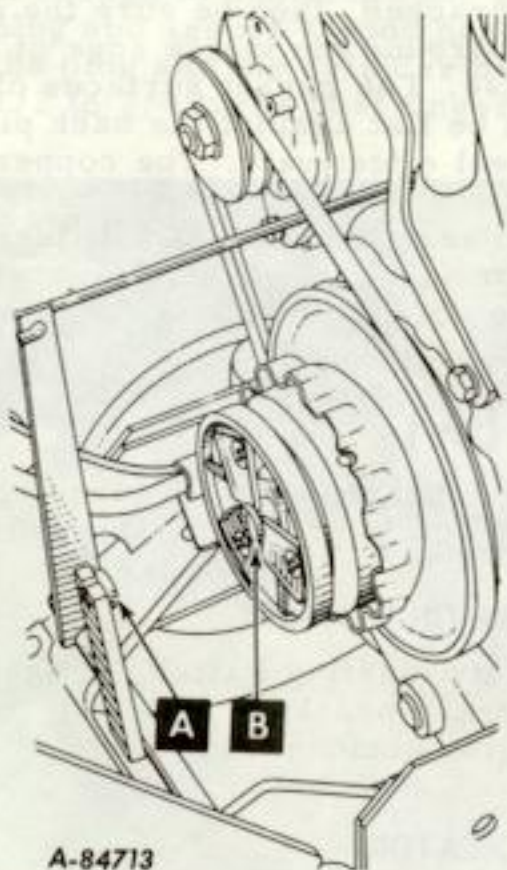

Illust. 15

View with grille removed to show engaging lever wear button and pressure spring thrust button.

After considerable clutch use, it may be necessary to readjust the button clearance as described below to assure proper clutch disengagement.

With the clutch fully engaged (clutch lever in the forward position) place a piece of thin cardboard (match book cover) approximately 1/64 inch thick between the engaging lever wear button "A" and the pressure spring thrust button "B" (**Illust. 15**), loosen the jam nut on the turnbuckle "C" (**Illust. 15A**), and adjust the turnbuckle until a light drag is felt on the cardboard when it is removed from between the buttons. Be sure all slack, except the 1/64 inch adjustment, is out of the linkage. Then, tighten the jam nut securely against the turnbuckle.

INSTALLING AND REMOVING DRIVE BELT

To install or remove the drive belt, loosen the clutch lever bolt enough so the lever can be moved forward to provide sufficient belt clearance between the engaging lever wear button "A" and the pressure spring thrust button "B". See **Illust. 15.**

After installing a new belt, move the clutch lever back onto the clutch lever latch and tighten the bolt. See **Illust. 15.**

Note: It is not always necessary to place the lever in the fully horizontal position as shown in **Illust. 15A.**

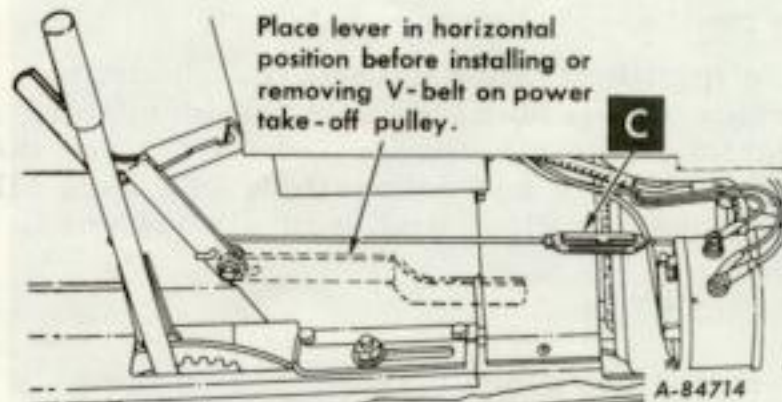

Illust. 15A

ENGINE COOLING AND AIR CLEANER

ENGINE COOLING

This tractor has an air cooled engine. Air must be able to circulate freely around the engine, through the screen and shroud, and over the fins of the cylinder head and cylinder block. Keep these areas free of accumulated dirt and trash or the engine will overheat and result in damaged moving parts.

DRY-TYPE AIR CLEANER

Incoming air for combustion is filtered by a dry-type air cleaner having a filter element inside of the cover.

Remove and clean or replace the element with a new one when loss of power is noticeable.

Cleaning the Element

To clean the element, remove the wing nut and air cleaner cover (Illustr. 16) then remove the element and tap it lightly on a flat surface to cause the loose dirt to fall off. Handle the paper element with care to avoid perforations. Do not use compressed air to remove the dirt as this can rupture the element. Do not wash or use a solvent.

IGNITION SWITCH

Turn the key clockwise to turn on the ignition. With electric starting, a further turn actuates the motor-generator. The key cannot be removed when in the "ON" position.

Note: When the engine is not operating or the engine has stalled and the operator leaves

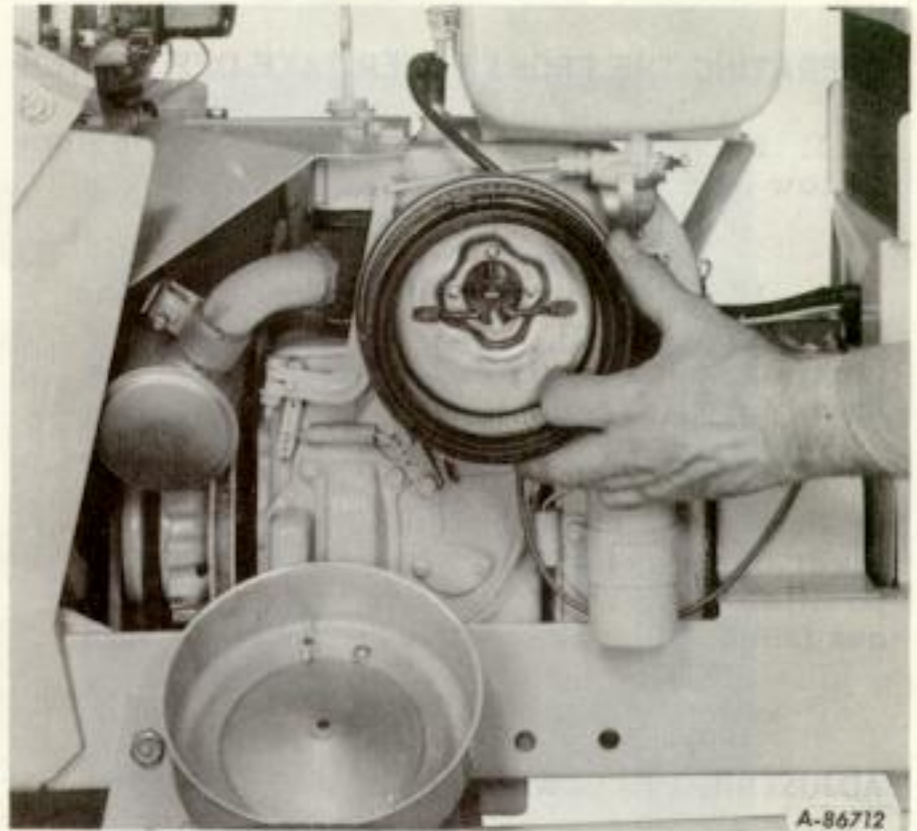

Illustr. 16
Removing the air cleaner filter element.

Replacing the Element

Replace the element with a new one if dirt does not drop off easily, or if it is bent, crushed or damaged. When replacing the element be sure the back plate is securely tightened to the carburetor. Replace the back plate if bent or cracked, then be sure the element fits snugly around the inside edge of the air cleaner base. The gasket surfaces of the element must be flat against the back plate and cover to seal effectively. The copper washer must be in place between the cover and the wing nut to seal and prevent unfiltered air from entering through the hole in the cover. Then replace the cover and tighten the wing nut finger tight.

ELECTRICAL SYSTEM

The twelve-volt electrical system on a tractor with electric starting consists principally of a motor-generator, voltage regulator, and a twelve-volt battery.

Use the illustrations on page 19 and wiring diagrams on page 20, as a guide for identifying the various electrical units and for tracing the electrical cables and connections. Be sure all connections are clean and securely fastened.

the tractor, the key must be turned to the "OFF" position to prevent battery discharge.

SAFETY STARTING SWITCH

The safety starting switch, activated by the clutch or brake pedal, serves to prevent starting the engine accidentally.

CHARGE INDICATOR

This instrument (Illustr. 5) indicates whether the motor-generator is charging or the battery is discharging. If it shows discharge continuously, investigate the cause to avoid completely discharging the battery and possible damage to the motor-generator. Refer to page 21 for additional information on electrical equipment.

ELECTRICAL SYSTEM

LIGHTING SWITCH BUTTON

Pull the button (Illustr. 19A) out to turn on the lights and push it in to turn off the lights.

CIGARETTE LIGHTER

Push the lighter to make electrical contact. When it pops back it is ready for use.

SPARK PLUG

Note: Remove all dirt from the base of the spark plug before removing the spark plug.

Remove the spark plug after every 100 hours of operation for cleaning and checking the gap. See Illustr. 17. When making this adjustment, always bend the outer electrode. Never bend the center electrode, as it may damage the insulator. If the gap between the electrodes is too great, the engine will misfire and be hard to start.

Always use a spark plug wrench when removing or reinstalling the plug.

Be sure the gasket is in good condition, and screw the plug in tightly. Do not tighten more than enough to compress the gasket to seal the plug and assure a good heat transfer between the plug and the cylinder head. Tighten the plug 1/2 to 3/4 turns past finger tight.



Illustr. 17
Checking the spark plug gap.
Set gap at .025-inch.

Replace a defective plug with a new plug. See your International Harvester dealer for a correct replacement plug.

IGNITION TIMING

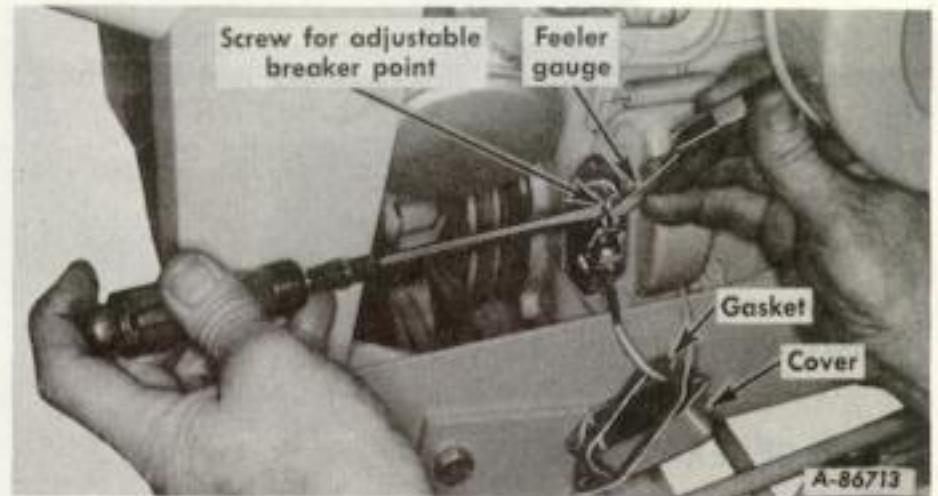

Illustr. 17A
Adjusting the breaker points.
Set gap at .020-inch.

Cleaning the Spark Plug

Sandblasting is the recommended method of cleaning the spark plug. Never scrape or clean the insulator with anything which will scratch the porcelain. Scratched porcelain allows carbon and dirt to accumulate much faster.

Remove the breaker point cover after every 100 hours of operation for cleaning the points and resetting the gap (Illustr. 17A). Replace badly pitted or burned points.

For more precise timing, a timing light should be used. The engine has a timing sight hole which is located in the right side of the engine bearing plate on the International Cub Cadet 72 Tractor or in the right side of the blower housing in the International Cub Cadet 104, 105, 124 and 125 Tractors. See Illustr. 17B.

With the engine running at 1/3 throttle, or more, adjust the breaker points until the "SP" mark on the flywheel is centered in the sight hole. **Note:** The "SP" mark will appear 20 degrees before top dead center. The other mark is the top center mark and is stamped with "DC" below the mark.

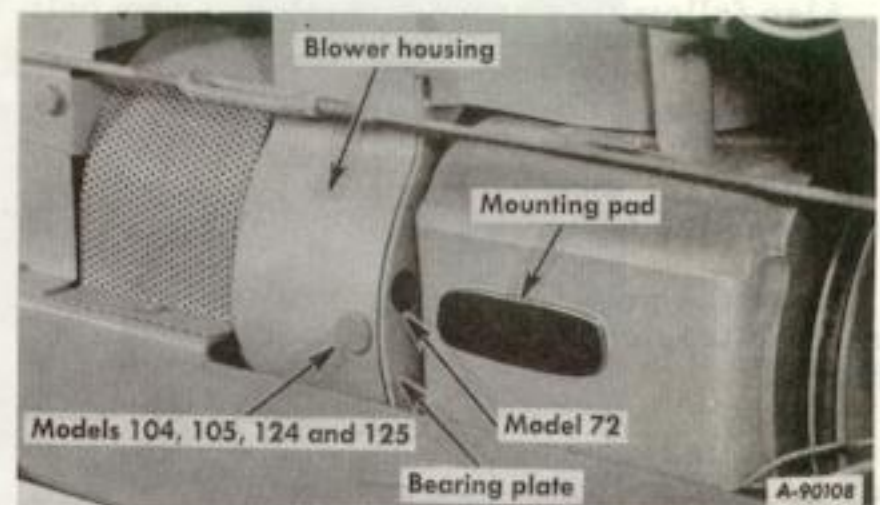

Illustr. 17B
Location of timing sight hole.
(Motor-generator has been removed to better illustrate the location).

MOTOR-GENERATOR

The motor-generator (12-volt, negative ground) will function as a cranking motor when the ignition key is turned to the "START" position, driving the engine by means of a belt.

When the engine is operating, the unit will function as a generator.

MOTOR-GENERATOR BELT

Check the tension of the motor-generator belt after the first 10 hours of operation and every 50 hours of operation thereafter. The tension is correct when the belt can be deflected a maximum of 1/4-inch by a ten pound force applied midway between the two pulleys.

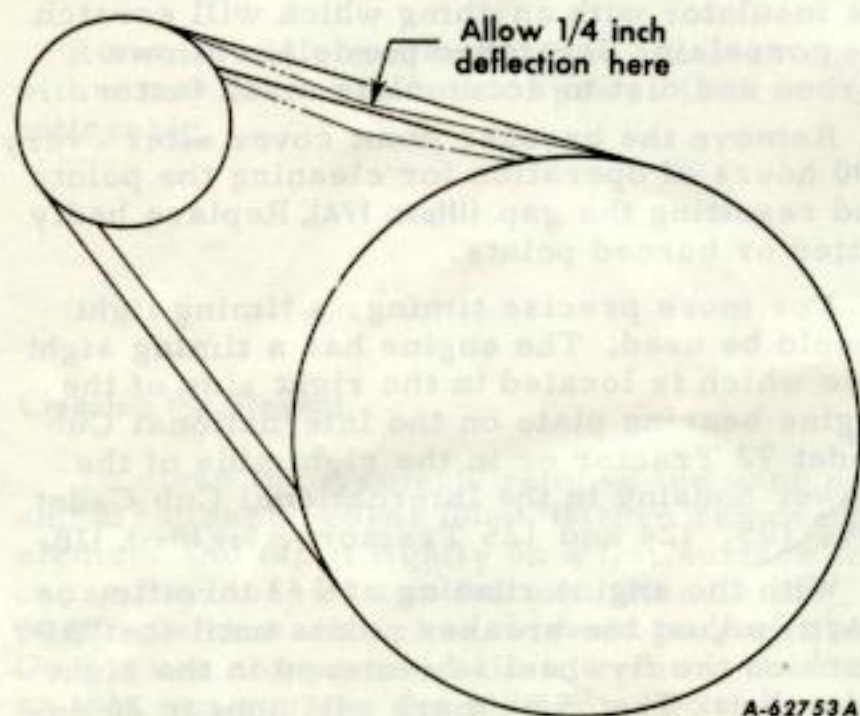

Illust. 18
Correct motor-generator belt tension.

Also follow this procedure when a new belt is installed.

Adjusting the Motor-Generator Belt

Loosen the motor-generator brace bolt "A" and mounting bolts "B", Illust. 19.

Move the generator away from the engine until the tension on the belt is correct. See Illust. 18.

Note: Under no circumstances should a pry bar be used on the motor-generator to obtain belt tension as damage to the bearings will result.

Tighten mounting bolts "B" and brace bolt "A".

Removing and Replacing the Motor-Generator Belt

Replace the motor-generator belt when it becomes badly worn. To remove the old belt, loosen the motor-generator brace bolt "A" and mounting bolts "B", Illust. 19. Move the generator in toward the engine and slip the old belt off the pulleys and over the crankshaft. Install the new belt in the reverse order of removal and adjust the belt to the proper tension.

VOLTAGE REGULATOR

A satisfactory generator charging rate is maintained by the voltage regulator. If the regulator fails to operate correctly, see your International Harvester dealer.

Note: Never place a jumper lead between, or accidentally bridge, the "BAT" terminal and the "F" terminal on the regulator, as this will damage the regulator.

LIGHTS

The headlights are sealed-beam lights. The parts are so constructed that the filament, reflector, and lens are all assembled in a unit permanently sealed against dirt, moisture, and corrosion. If a filament burns out or a lens breaks, the complete unit must be replaced. Refer to "SPECIFICATIONS".

TAILLIGHT

To replace the taillight lamp, remove the lens from the taillight and replace the taillight lamp with a 4 candle power lamp. Refer to "SPECIFICATIONS".

FUSE (Electric Lighting)

It is important to use the same capacity fuse for replacement. Refer to "Specifications". If the lights fail, check the fuse. If a fuse continually burns out, check the electrical wiring for short circuits.

The fuse is located in a fuse housing in the line at the back of the instrument panel. See Illust. 20.

To install a new fuse, press in on the fuse housing cap and turn counterclockwise to remove it from the fuse housing. Remove the old fuse and replace it with a new one. Then reassemble the cap to the housing. Remove the battery if necessary to reach the fuse.

ELECTRICAL SYSTEM

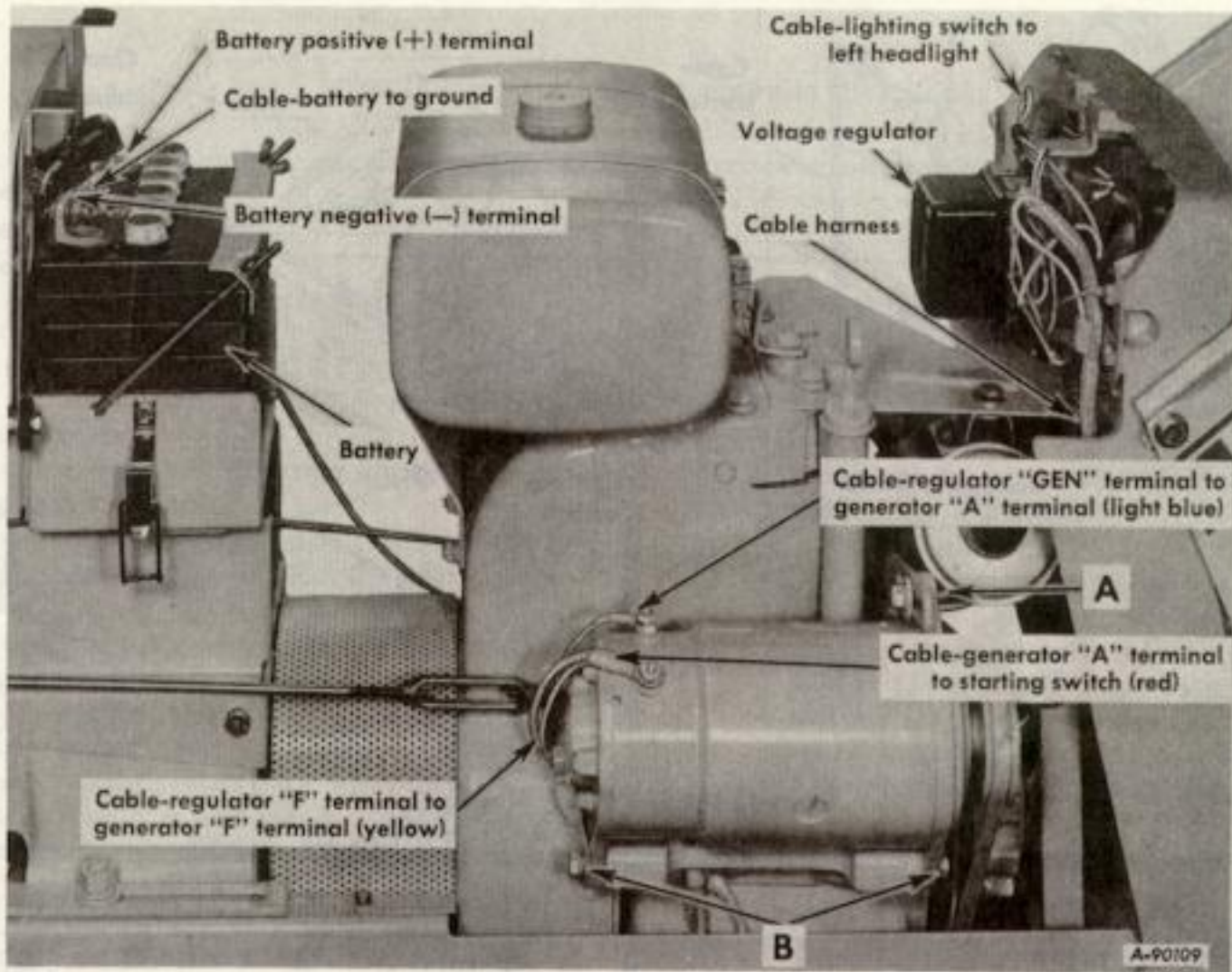

Illust. 19

Electrical units on the right side of the tractor.

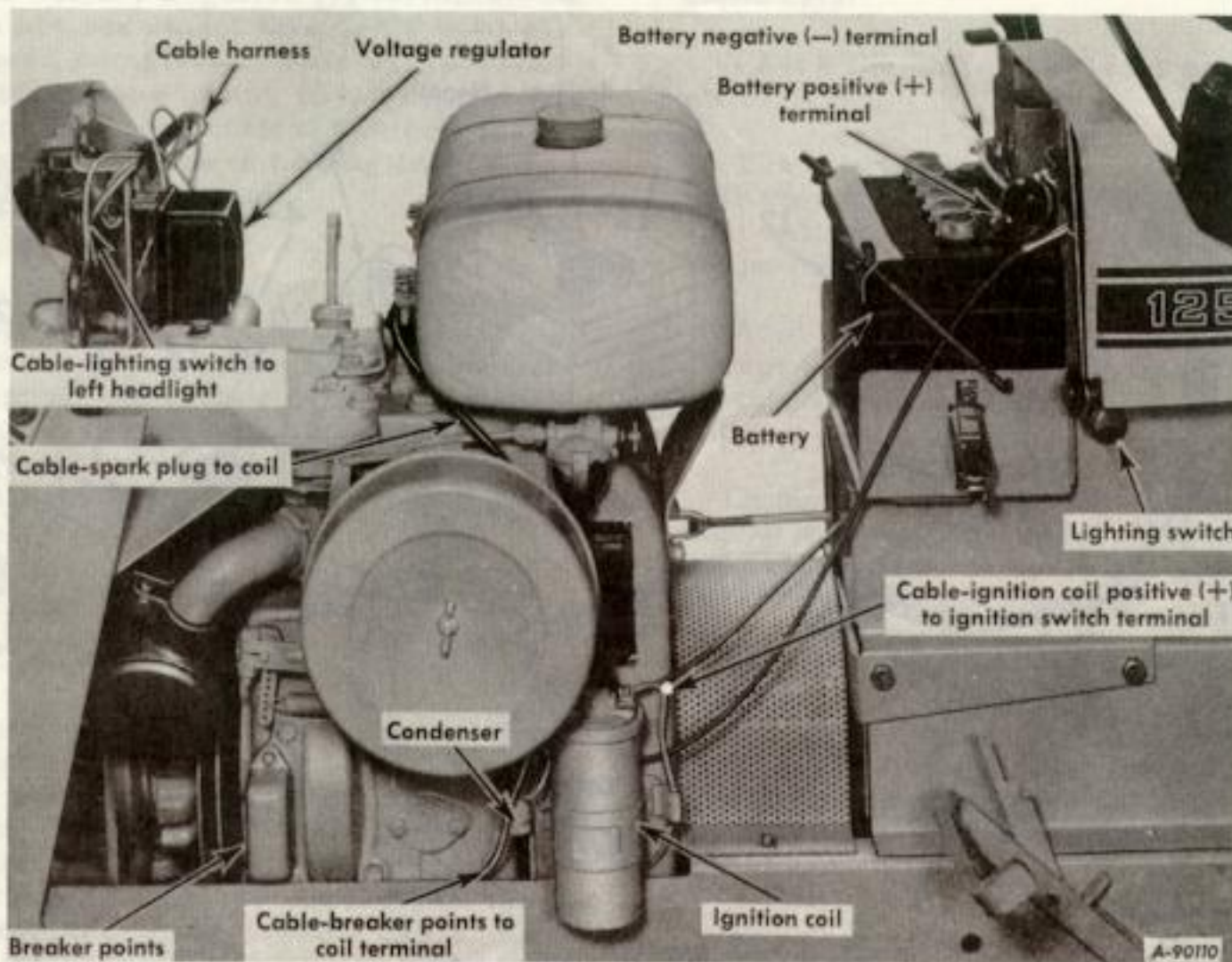

Illust. 19A

Electrical units on the left side of the tractor.

ELECTRICAL SYSTEM

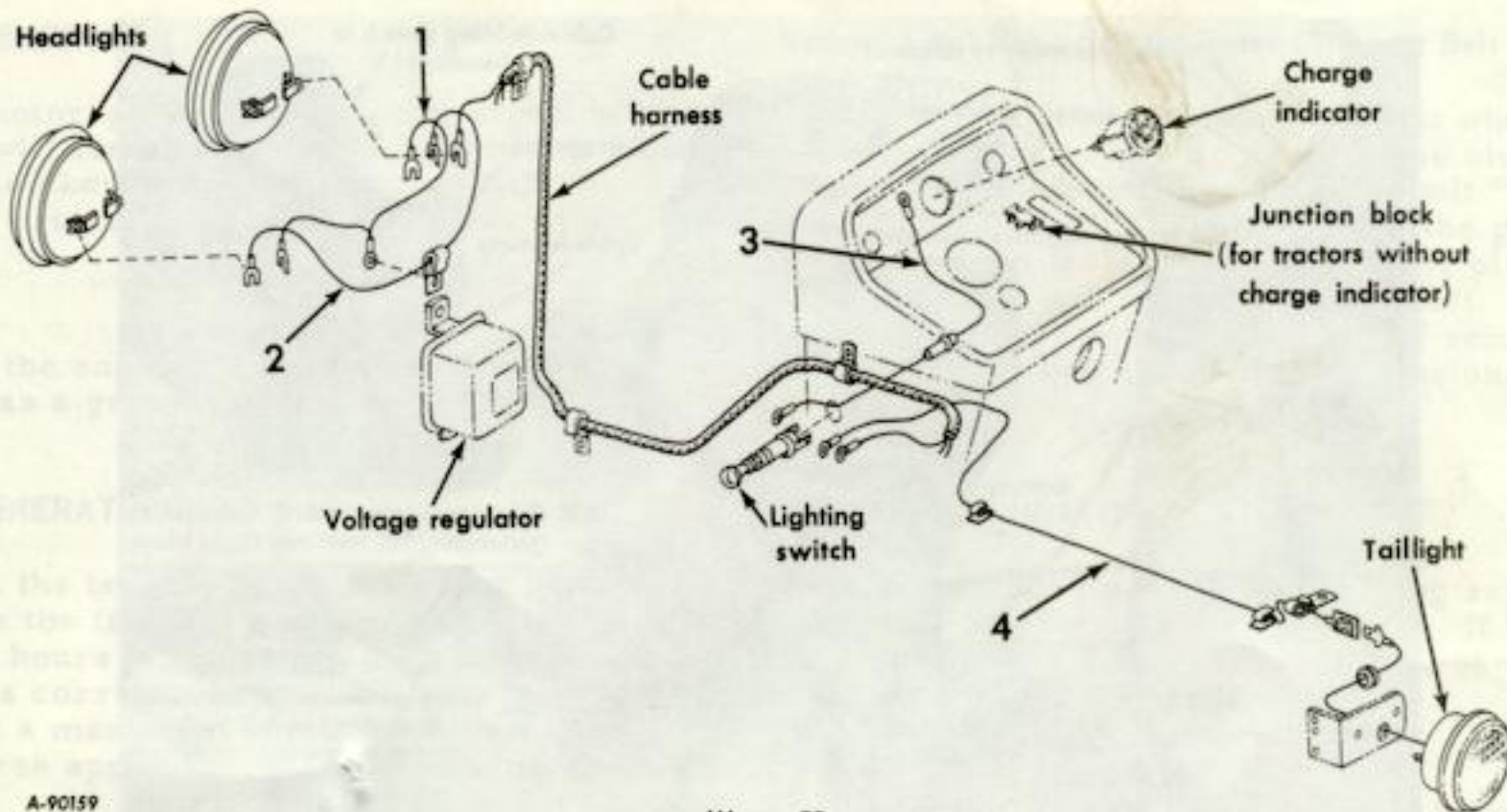

A-90159

Illust. 20
Electric lighting wiring diagram.
Index to reference numbers shown in Illust. 20.

Ref. No.	Description	Ref. No.	Description
1	Cable - headlight to ground.	3	Cable - with-in-line fuse lighting switch to charge indicator.
2	Cable - right headlight to left headlight.	4	Cable - lighting switch to taillight.

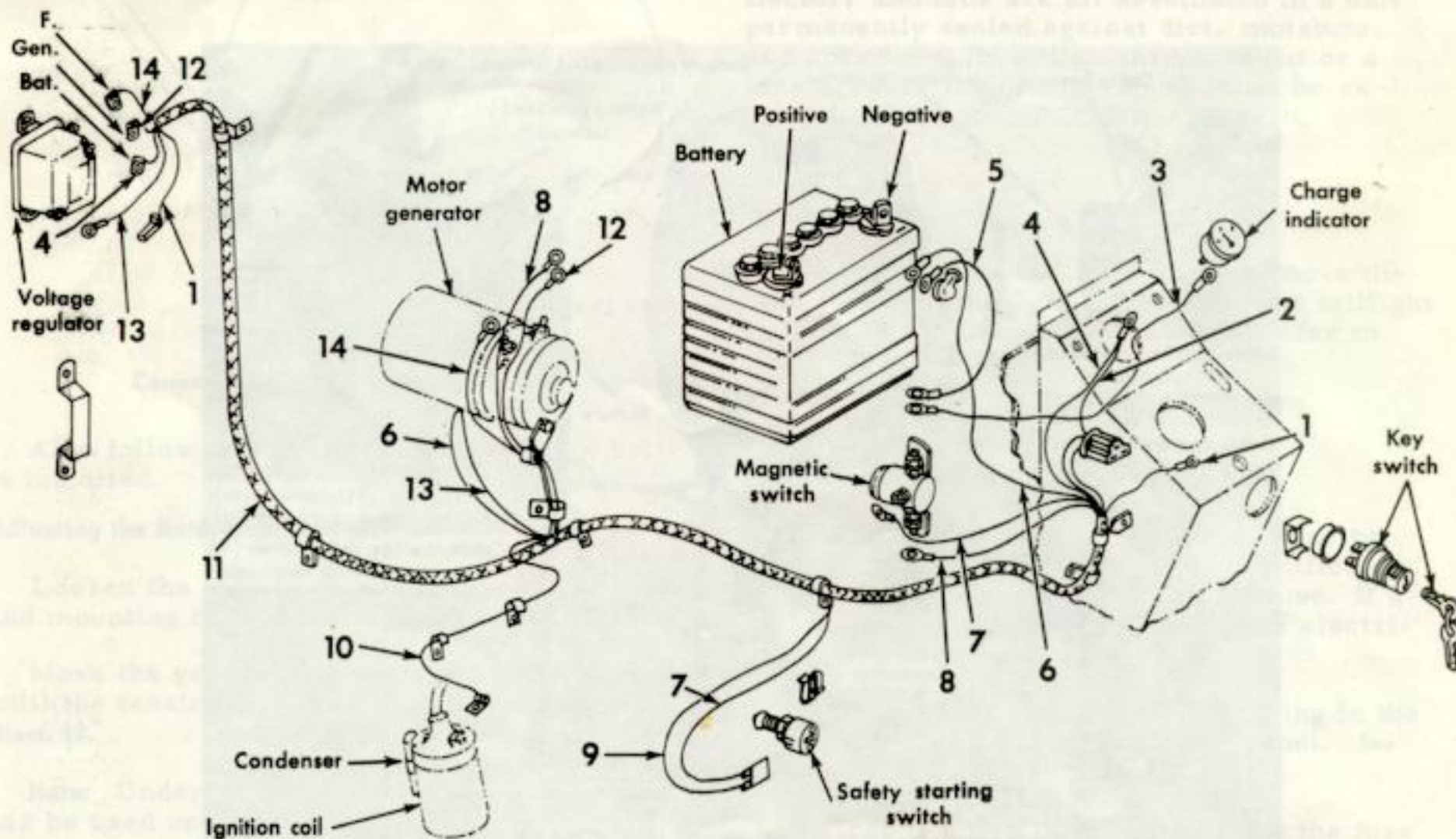

Tractors with electric starting
Illust. 20A
Electric Starting Wiring Diagram.
See index to reference numbers on page 21.

A-90171

ELECTRICAL SYSTEM

Index to reference numbers shown in Illust. 20A.

Ref. No.	Description	Ref. No.	Description
1	Cable - lighting switch to headlamp junction - violet.	8	Cable - magnetic switch to generator "A" terminal - red.
2	Cable - key switch "BAT" terminal to charge indicator "NEG." terminal - light green.	9	Cable - safety starting switch to key ignition switch "ST" terminal - orange.
3	Cable assembly. Charge indicator to magnetic switch.	10	Cable - ignition coil positive (+) terminal to key ignition switch "IGN" terminal - black.
4	Cable - charge indicator "NEG." terminal to regulator "BAT" terminal - gray.	11	Cable harness.
5	Cable - battery positive (+) terminal to magnetic switch.	12	Cable - regulator "GEN" terminal to generator "A" terminal - light blue.
6	Cable - battery negative (-) terminal to motor generator ground - white.	13	Cable - ground junction to voltage regulator base ground - white with black tracer.
7	Cable - safety starting switch to magnetic switch - orange w/black tracer.	14	Cable - generator "F" terminal to voltage regulator "F" terminal - yellow.

STORAGE BATTERY

Battery and Cables

Before working on any part of the electrical system, disconnect the battery ground cable at the battery negative (-) terminal. See **Illust. 19**. Do not reconnect this cable until all work has been completed. This will prevent shorting and damage to any of the electrical units. Examine the electrical cables occasionally to be sure they are not being frayed by contact with adjacent parts.

When replacing a battery, make certain the ground cable is connected to the negative (-) terminal on the battery. Be sure the rubber boot is properly positioned over the positive (+) terminal on the battery. **Note:** Both cables must be assembled with the nuts to the inside of the terminals to prevent shorting against the pedestal.

Cleaning and Servicing the Battery

Occasionally remove the battery cables and brighten the terminal contact surfaces with wire wool, and reassemble them. Apply a light coat of vaseline or chassis lubricant. Be sure the terminals are clamped tightly and that the battery is fastened securely in the battery box. Replace unserviceable cable. Keep the vent holes in the battery filler caps open.

Keeping the battery fully charged not only adds to its life but makes it available for instant use when needed.

Liquid Level

Check the battery at least once a month for water level.

The electrolyte (acid and water) in each cell should be at ring level at all times to prevent battery failure. When the electrolyte is below this level, add pure, distilled water.

Acid or electrolyte should never be added except by a skilled battery man. Under no circumstances add any special battery "dopes," solutions or powders.

Caution! Electric storage batteries give off highly inflammable hydrogen gas when charging and continue to do so for some time after receiving a steady charge.

Caution! Do not under any circumstances allow an electric spark or an open flame near the battery. Do not lay tools across battery terminals as this may result in a spark or short circuit which may cause an explosion. Be careful to avoid spilling any electrolyte on hands or clothing.

For dependable battery service, see your International Harvester dealer.

FRONT WHEELS

FRONT WHEEL TOE-IN

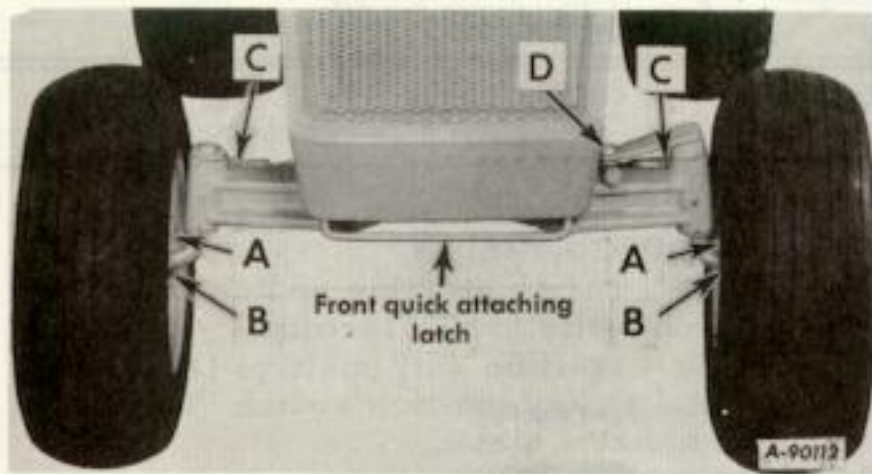

Illust. 22
Front wheel adjustments.

The front wheel toe-in dimension is 1-32-inch to 1/8-inch toe-in (1/32-inch to 1/8-inch closer in front than in the rear). Measure the distance between two points "A" and two points "B" Illust. 22. Points "A" and "B" must be on the inside of the wheels at the outer edges and at the same height from the ground as the front wheel hubs.

To adjust the toe-in, disconnect either tie rod ball joint "C" (Illusts. 22 and 22A) loosen

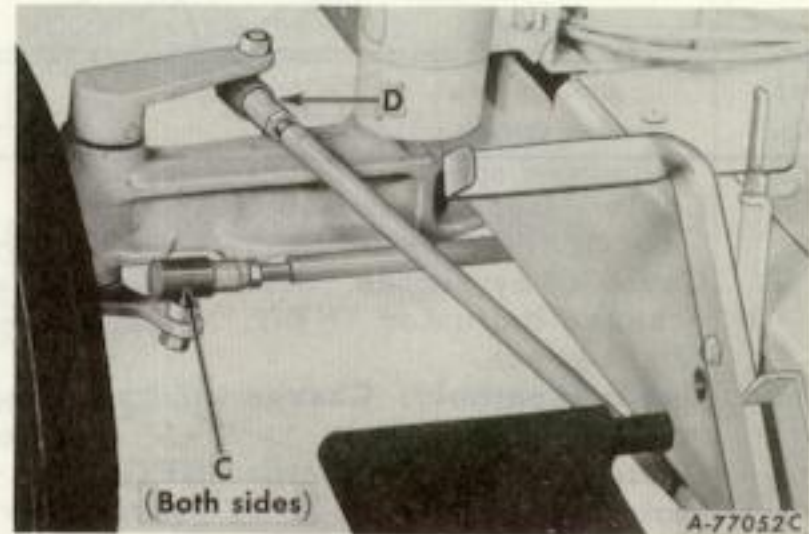

Illust. 22A
Tie rod and drag link ball joints.

the lock nut, and turn the tie rod ball joint end in or out as required.

TURNING RADIUS

The front wheels should have an equal angle for left and right turns. If adjustment is necessary, disconnect the drag link ball joint "D" (Illusts. 22 and 22A) loosen the lock nuts and turn the drag link ball joint in or out as required.

PNEUMATIC TIRES

REAR TIRES

6-12 rear tires are standard equipment on the International Cub Cadet 72 and 104 Tractors.

23 x 8.50 - 12 Terra-Tires are standard equipment on the International Cub Cadet 124 and 125 Tractors. They are also available as extra equipment when ordered for the International Cub Cadet 72, 104, and 105 Tractors.

The Terra-Tires provide maximum mobility in sand, snow, and soft soil conditions. The reduced ground pressure and low inflation provides maximum protection for turf, soil, and crops.

CARE OF TIRES

Avoid stumps, stones, deep ruts and other hazards. Cuts in tires should be repaired immediately as neglect decreases the tire life.

Keep tires free from oil and grease as both destroy rubber.

After using the tractor for spraying—insect control work—use water to remove any chemicals that may be on the tires.

INFLATION

Keep the pneumatic tires properly inflated. Underinflation will damage the tire cord body and may also cause the tire to slip on the rim, thus tearing out the tube valve stem.

Always see that the tire valve caps are in place and tightened securely to prevent the loss of air and protect the valve core and stem.

PNEUMATIC TIRES

OPERATING PRESSURE FOR TIRES

Inflate the front and rear tires for normal or heavy load operations as shown in the following table.

Tire Size	Normal Load Operations	Heavy Load Operations
Front Tires	Pounds per square inch	
4.80/4.00-8	8	10
16 x 6.50-8	6	6
Rear Tires		
6-12	6	8
23 x 8.50-12	6	6

MOUNTING TIRES ON THE RIM

After mounting a new or old tire on the rim, inflate it to 20 pounds pressure to seat the tire bead on the rim flange and to prevent the tire from creeping and shearing off the valve. Then deflate the tire to the correct operating pressure.

REAR WHEEL WEIGHTS

Rear wheel weights increase traction and reduce wheel slippage. The weights weigh approximately 26 pounds each. They are attached to each rear wheel with two bolts, lock washers, and hex. nuts.

If additional weight is desired, a second set of weights can be attached to each first weight by using two longer bolts.

TIRE CHAINS

Tire chains will provide additional traction for wet ground conditions, when plowing snow, or pulling heavy loads. Rear wheel weights are recommended when using chains.

CLUTCH AND BRAKE

(International Cub Cadet 72, 104 and 124 Tractors)

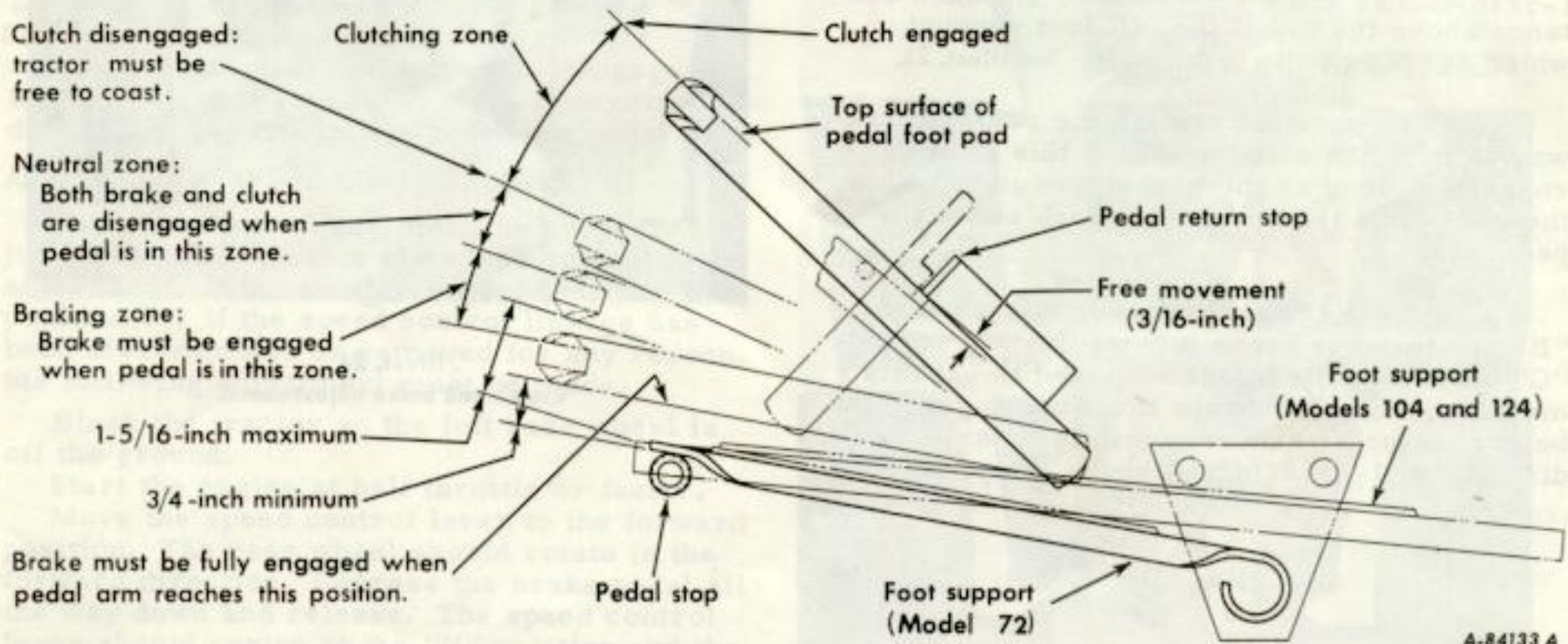

Illust. 23

Clutch and brake adjustments.

CLUTCH AND BRAKE

(International Cub Cadet 72, 104 and 124 Tractors)

As the clutch and brake are both operated by the same pedal, care must be taken to maintain a neutral zone so the clutch is disengaged when the brake is applied.

ADJUSTING THE CLUTCH

It is important that a clearance of .050-inch be maintained between the clutch release lever and the clutch release bearing. In order to maintain this clearance, the pedal should have a free movement of approximately 3/16-inch. See *Illust. 23*. This measurement is taken at the point of contact of the pedal arm with the front edge of the pedal return stop.

The clutch pedal adjustments are set at the factory and should not require frequent attention unless the linkage has been disturbed or when the pedal movement becomes less than 3/16-inch. When it is necessary to adjust the clutch, turn the adjusting nut "A" on the clutch release rod (*Illust. 24*) in or out as required to get the proper measurements.

ADJUSTING THE BRAKE

The brake should engage when the pedal arm is pressed down to within a maximum of 1-5/16-inches and a minimum of 3/4-inch distance above the top of the left foot support, which serves as the pedal stop. See *Illust. 23*.

It may be possible to push the pedal all the way down to the pedal stop, but this is of no concern as long as the brake is engaged when the pedal arm is at least 3/4-inch above the pedal stop.

To adjust the brake, loosen the jam nut "B" and turn the brake lever adjusting screw "C" (*Illust. 24*) in or out as required to get this measurement. The brake must not engage before the pedal arm is within the maximum distance of 1-5/16-inches above the pedal stop.

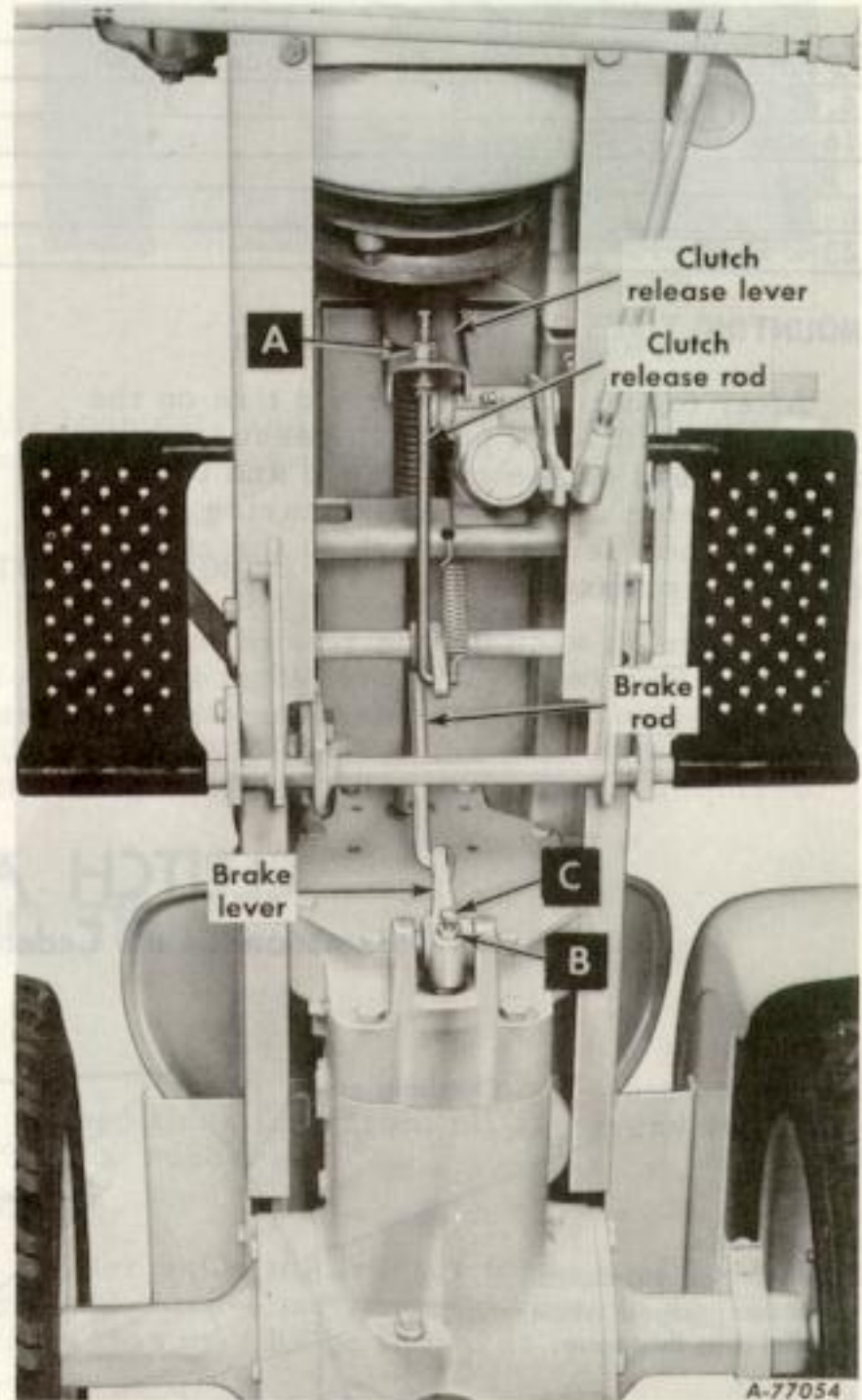

Illust. 24
Clutch and brake adjustments.

BRAKE

(International Cub Cadet 105 and 125 Tractors)

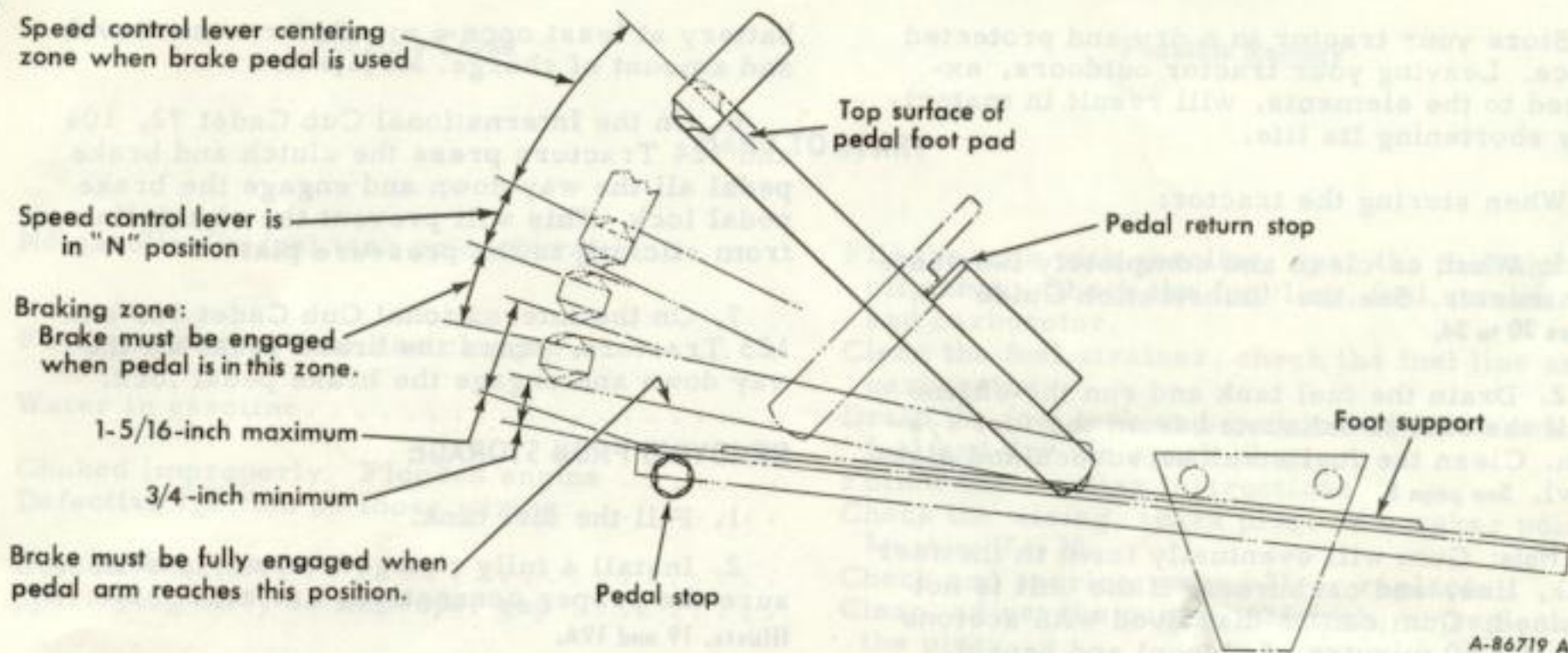

Illustr. 25
Brake adjustments.

ADJUSTING THE BRAKE

The brake should engage when the pedal arm is pressed down to within a maximum of 1-5/16-inches and a minimum of 3/4-inch distance above the top of the left foot support, which serves as the pedal stop. See Illustr. 25.

It may be possible to push the pedal all the way down to the pedal stop, but this is of no concern as long as the brake is engaged when the pedal arm is at least 3/4-inch above the pedal stop.

To adjust the brake, loosen the jam nut "B" and turn the brake lever adjusting screw "C" (Illustr. 25A) in or out as required to get this measurement. The brake must not engage before the pedal arm is within the maximum distance of 1-5/16-inches above the pedal stop.

ADJUSTING THE SPEED CONTROL LEVER

Note: The brake pedal must be properly adjusted before beginning the speed control lever adjustment. If the tractor "creeps" in the "N" position or, if the speed control linkage has been disassembled or removed for any reason, the following adjustment must be made.

Block the tractor so the left rear wheel is off the ground.

Start the engine at half throttle or faster.

Move the speed control lever to the forward position. The rear wheel should rotate in the forward direction. Depress the brake pedal all the way down and release. The speed control lever should return to the "N" position and the rear wheel stop turning.

If the rear wheel turns in the forward direction, loosen jam nut "D" and turn the connecting rod "E" counterclockwise to lengthen it until the wheel stops turning. (See Illustr. 25A).

If the wheel turns in the reverse direction turn the connecting rod "E" clockwise. Tighten the jam nut "D".

If this adjustment does not stop "creeping" see your International Harvester dealer.

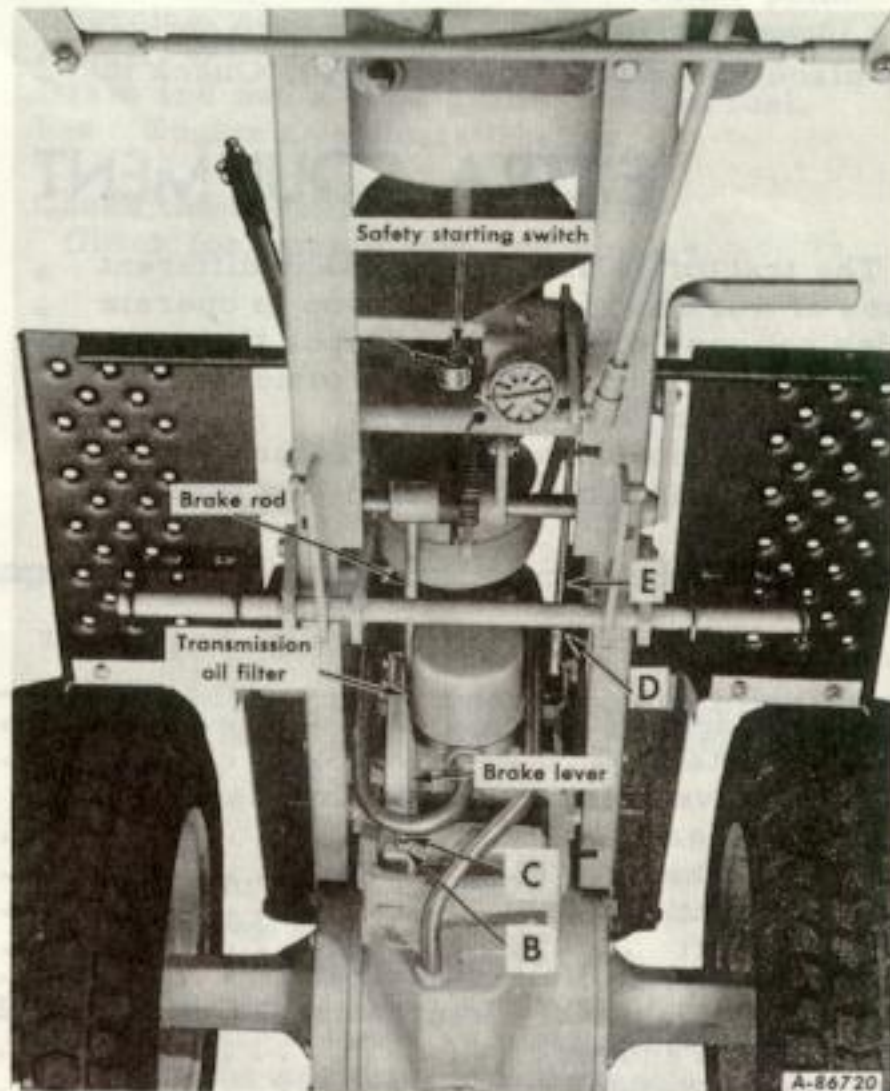

Illustr. 25A
Brake adjustments.

STORING THE TRACTOR

STORAGE

Store your tractor in a dry and protected place. Leaving your tractor outdoors, exposed to the elements, will result in materially shortening its life.

When storing the tractor:

1. Wash or clean and completely lubricate the tractor. See the "Lubrication Guide" on pages 30 to 34.

2. Drain the fuel tank and run the engine until the fuel is exhausted from the fuel system. Clean the fuel strainer screen and glass bowl. See page 8.

Note: Gum will eventually form in the fuel tank, line, and carburetor if the unit is not drained. Gum can be dissolved with acetone or a 50-50 mixutre of alcohol and benzol.

3. After the engine has cooled, remove the spark plug and pour one tablespoonful of lubricating oil of good quality into the cylinder. Crank the engine slowly turning the generator belt by hand to distribute the oil over the cylinder walls. Then replace the spark plug.

4. Clean the exterior of the engine.

5. Remove the battery and place it in a cool, dry place above freezing (+32°F.). Check the

battery at least once a month for water level and amount of charge. See page 21.

6. On the International Cub Cadet 72, 104 and 124 Tractors press the clutch and brake pedal all the way down and engage the brake pedal lock. This will prevent the clutch lining from sticking to the pressure plate.

7. On the International Cub Cadet 105 and 125 Tractors, press the brake pedal all the way down and engage the brake pedal lock.

REMOVING FROM STORAGE

1. Fill the fuel tank.

2. Install a fully charged battery and be sure the proper connections are made. See Illusts. 19 and 19A.

3. Start the engine and let it run slowly. Do not accelerate the engine rapidly, or operate it at high speed immediately after starting.

Caution! Keep the doors wide open or move the machine outside the storage room immediately, to avoid danger from exhaust gas.

4. Inflate the tires to the correct operating pressures. See "Pneumatic Tires" on pages 22 and 23.

5. Release the brake pedal lock.

EXTRA EQUIPMENT AND ACCESSORIES

The tractor is used for so many different types of work and is called on top to operate under so many different conditions that a variety of equipment is available to adapt it to the requirements of the user.

When you purchased your tractor, you probably had it completely equipped for your

particular needs at the time. However, later you may wish to obtain some of the equipment or accessories shown below. These items and other allied equipment can be purchased from, and installed by, your International Harvester dealer.

Type of Equipment	Models used on				
	72	104	105	124	125
Cigarette Lighter	x	x	x	x	x
Charge Indicator	x	-	-	-	-
Creeper Drive ("International Cub Cadet 72, 104 and 124 Tractors") . . .	x	x	-	x	-
Detachable Seat Pad	x	-	-	-	-
Dual Rear Wheels	x	x	x	x	x
Electric Lighting	x	x	x	x	x
Hydraulic Lift	x	x	x	x	x
Implement Handle Helper Spring	x	x	x	x	x
Rear Power Take-Off ("International Cub Cadet 72, 104, and 124 Tractors")	x	x	-	x	-
Rear Wheel Fenders	x	-	-	-	-
Rear Wheel Weights	x	x	x	x	x
Three-Point Hitch	x	x	x	x	x
Utility Box	x	x	x	x	x

TROUBLE SHOOTING

Possible Cause

Possible Remedy

HARD TO START

No gasoline in fuel tank or carburetor	Fill the tank with gasoline; open the fuel shut-off valve. Check the fuel line, fuel strainer and carburetor.
Fuel strainer or fuel line clogged	Clean the fuel strainer, check the fuel line and carburetor.
Water in gasoline	Drain the fuel tank and carburetor. Use new fuel and dry the spark plug.
Choked improperly. Flooded engine	Follow the starting instructions.
Defective ignition or loose wiring	Check the wiring, spark plug, or breaker points. See pages 17 to 20.
Defective battery	Check and service; see page 21 , or replace.
Spark plug dirty or improper gap	Clean, adjust the gap to .025 inch, or replace the plug.

ENGINE OPERATES IRREGULARLY OR KNOCKS

Engine incorrectly timed.	See "Breaker Points and Spark Plug" on pages 17 and 18.
Spark plug dirty; wrong gap or wrong type . . .	Clean, reset the gap to .025 inch, or replace.
Poor or weak spark	Check the breaker points and breaker point opening, spark plug, and wiring; see pages 17 to 20 .
Carburetor setting incorrect	Adjust; see "Carburetor" on pages 8 and 9.
Poor grade fuel or water in fuel	Drain and use a good grade of clean fuel.
Engine overheating	See "Engine Overheats" below.
Engine valves at fault	*
Engine smokes.	Check the carburetor. Check for worn piston and rings.*
Excessive carbon in engine	*
Loose piston pin or bearings	*
Broken rings or loose piston	*
Worn connecting rod and main bearings	*
Governor sticking or needs adjustment.	*

LACK OF POWER

Engine cold or overheated	Run the engine until it warms up before putting it under load. See "Engine Overheats" below.*
Engine overloaded	Reduce the load.
Governor not working properly.	*
Poor compression	*
Poor fuel or too lean a mixture.	See "Carburetor" on pages 8 and 9.
Fuel line or strainer obstructed	Clean; see page 8 .
Fuel tank air vent closed.	Open the vent in the cap.
Air cleaner clogged or air leakage between carburetor and engine	Clean the air cleaner as instructed on page 16. Tighten the carburetor and manifold mounting nuts.

* See your International Harvester dealer.

STORM TROUBLE SHOOTING DR

STORAGE

Possible Cause

Possible Remedy

LACK OF POWER - Continued

Incorrect timing or faulty ignition	See "Breaker Points and Spark Plug" on pages 17 and 18.
Clutch slipping (Models 72, 104 and 124)	Adjust the free travel of the pedal; see pages 23 and 24.
Brake drags	Adjust the brake; see pages 23 and 24.

ENGINE OVERHEATS

Insufficient cool air, dirty air intake screen, shroud, or cooling fins	Keep the air intake area and cooling fins clean; See "Engine Cooling and Air Cleaner" on page 16.
---	---

CREEPING

Speed control lever out of adjustment (Models 105 and 125) See "Speed Control Lever Adjustment" on page 25.

* See your International Harvester dealer.

LUBRICATION

ENGINE OIL

The tractor is shipped from the factory with shipaway engine oil in the crankcase. If the engine is to be operated at temperatures between +75 degrees F and 0 degrees F, this oil can be used for the first five hours of operation. If the temperatures are not within this range, drain the oil from the crankcase and replace it with new oil as specified in the "Lubrication Table". The engine oil must be drained and replaced with new oil every 30 hours of engine operation thereafter.

Oils designated "For Service MS" are recommended for this engine.

To aid starting, the selection of crankcase lubricating oils should be based on the lowest anticipated temperature until the next drain period.

Check the oil levels of the engine crankcase and transmission to see that they are filled to the correct levels. **Note:** Check the oil level only while the engine is stopped.



Illust. 28
Oil level gauge.

LUBRICATION

The crankcase oil filler cap has the oil level gauge attached to it. See **Illust. 28**. Always keep the oil level between the "FULL" and the "LOW" marks on the gauge. When checking the oil level, the gauge must be withdrawn and wiped clean, then inserted all the way and withdrawn for a true reading.

Lubricate the entire tractor, using only high-quality lubricating oils and greases as specified in the "Lubrication Table". For your own protection, select only oils and greases of recognized manufacture.

Keep your supply of lubricating oil absolutely clean and free from dust. Always use clean containers. Keep the lubricator clean and wipe dirt from the lubrication fittings before applying the lubricator.

TRANSMISSION OIL FILTER (International Cub Cadet 105 and 125 Tractors)

Remove the throwaway can-type filter (**Illust. 25A**) and replace with a new filter after the first 10 hours and after 50 hours of operation, and every 100 hours of operation thereafter.

Note: Clean the outside area before removing the filter to keep dirt from getting into the transmission case. If a mower is mounted on the tractor, the mower must be lowered to facilitate the removal of the filter.

To remove the filter, turn the filter counterclockwise using an automotive type filter wrench or an open end wrench.

Before installing the new filter, apply a coating of oil on the filter gasket. Thread the filter on by hand until tight enough to seat the gasket.

Loosen the filter. Then turn it until the gasket contacts the base. Tighten the filter an additional three quarter turn. Check for leaks.

LUBRICATION TABLE

Point of Lubrication	Fill at Hours	Change at Hours	Capacity	Anticipated Air Temperature		
				Above +32° F.	+32° F. to 0° F.	Below 0° F.
Engine crankcase Model 72 Tractor	10	30	2-1/2 pt.	SAE-30 engine oil	SAE-10W engine oil	SAE-5W or SAE-5W-20 engine oil
Models 104, 105, 124, and 125 Tractor	10	30	3 pt.			
Transmission Models 105 and 125 Tractor	100	Yearly	7 qt.	IH Hy-Tran® Fluid		
Models 72, 104, and 124 Tractor	100	Yearly	7 pt.	IH Hy-Tran® Fluid or SAE-30 engine oil		
Creeper drive housing Models 72, 104, and 124 Tractors	100	Yearly	1/2 pt.			
Steering gear housing All models	Yearly	-	1/4 lb.	Two strokes of the lubricator using IH-251 HEP grease or equivalent #2 multi-purpose lithium grease.		
Steering knuckles All models	10	-	Use IH-251 HEP grease or equivalent #2 multi-purpose lithium grease and apply two or three strokes of the lubricator or sufficient grease to flush out old grease and dirt.			

LUBRICATION GUIDE

(International Cub Cadet 72, 104 and 124 Tractors)

The symbols around the reference numbers indicate the intervals of lubrication.

- ▲ -- 10 hours,
- -- 30 hours,
- ▼ -- 100 hours,
- -- Periodic

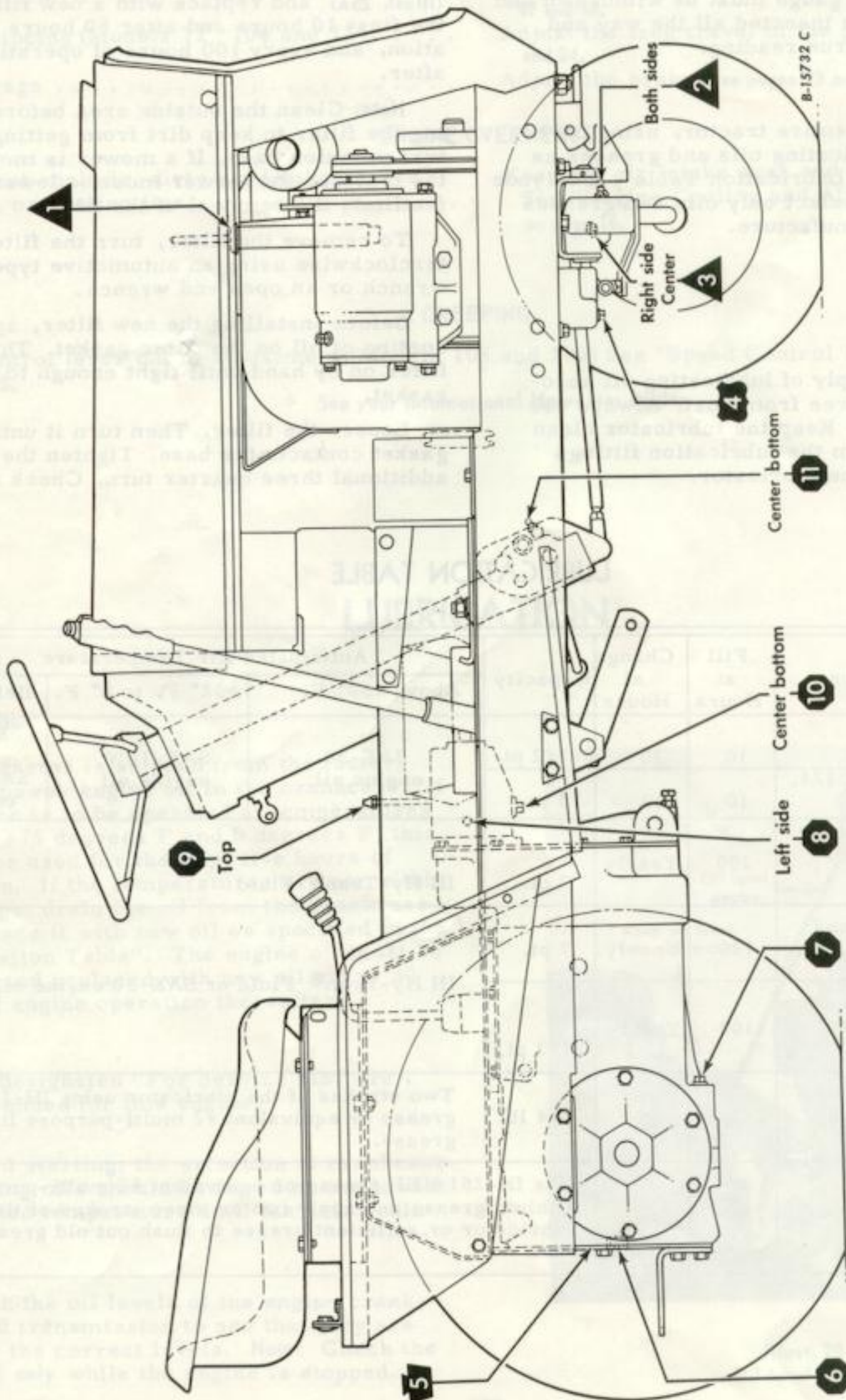

Illustr. 30
Lubrication view.

LUBRICATION GUIDE

(International Cub Cadet 72, 104 and 124 Tractors)

▲ -- After Every 10 Hours of Operation

1 - Oil filler cap and bayonet-type oil level gauge.

Check the oil (with the engine stopped) and add sufficient new oil to bring it to the "FULL" mark on the gauge. Do not overfill. Do not operate the engine if the oil level is below the "LOW" mark on the gauge.

2 - Steering knuckles (2).
3 - Front axle pivot pin.

Use IH-251 HEP grease or equivalent #2 multi-purpose lithium grease and apply sufficient grease to flush out old grease and dirt.

■ -- After Every 30 Hours of Operation

4 - Engine crankcase.

While the oil is warm, remove the drain plug (4) and drain all of the oil from the crankcase. Replace the drain plug. Remove the crankcase oil filler cap (1). Refill the crankcase with new oil up to the "FULL" mark on the oil level gauge. Refer to the "Lubrication Table" for the proper quantity and viscosity to use.

▼ -- After Every 100 Hours of Operation

5 - Power take-off shaft bearing

Use IH-251 HEP grease or equivalent #2 multi-purpose lithium grease and apply two or three strokes of the lubricator to the lubrication fittings.

● -- Periodic

Transmission

6 - Oil level and filler plug.
7 - Oil drain plug.

Check the oil level periodically. Keep the lubricant up to the level plug (6) on the rear of the transmission case. Change the oil in the transmission case at least once a year. Remove the drain plug (7) and remove the oil level and filler plug (6) and allow all of the oil to drain out. Replace the drain plug. Refill with approved lubricant up to the level plug opening and replace the plug.

Creeper drive housing

8 - Level plug.
9 - Breather and filler plug.
10 - Drain plug.

Check the oil level periodically. Keep the lubricant up to the level plug (8) on the left side of the creeper drive housing. Drain and refill the housing each time the oil is changed in the transmission case. To change the oil, remove the drain plug (10) at the bottom of the housing and allow all the oil to drain. Then replace the drain plug. Remove the breather and oil filler plug (9) at the right of the creeper shift handle on top of the frame assembly, and remove the oil level plug (8). Fill to the level plug opening with approved lubricant and replace the plugs.

11 - Steering gear housing.

Once a year, apply two strokes of the lubricator, using IH-251 HEP grease or equivalent #2 multi-purpose lithium grease.

Note: To locate the lubrication fitting, turn the front wheels to the maximum right turn position. Then reach up under the right side of the tractor frame to locate the fitting.

Miscellaneous

Lubricate the clutch pedal shaft and linkage with eight or ten drops of engine oil.

LUBRICATION GUIDE

(International Cub Cadet 105 and 125 Tractors)

The symbols around the reference numbers indicate the intervals of lubrication.

- ▲ --10 hours,
- --30 hours,
- --50 hours,
- ▼ --100 hours,
- --Periodic

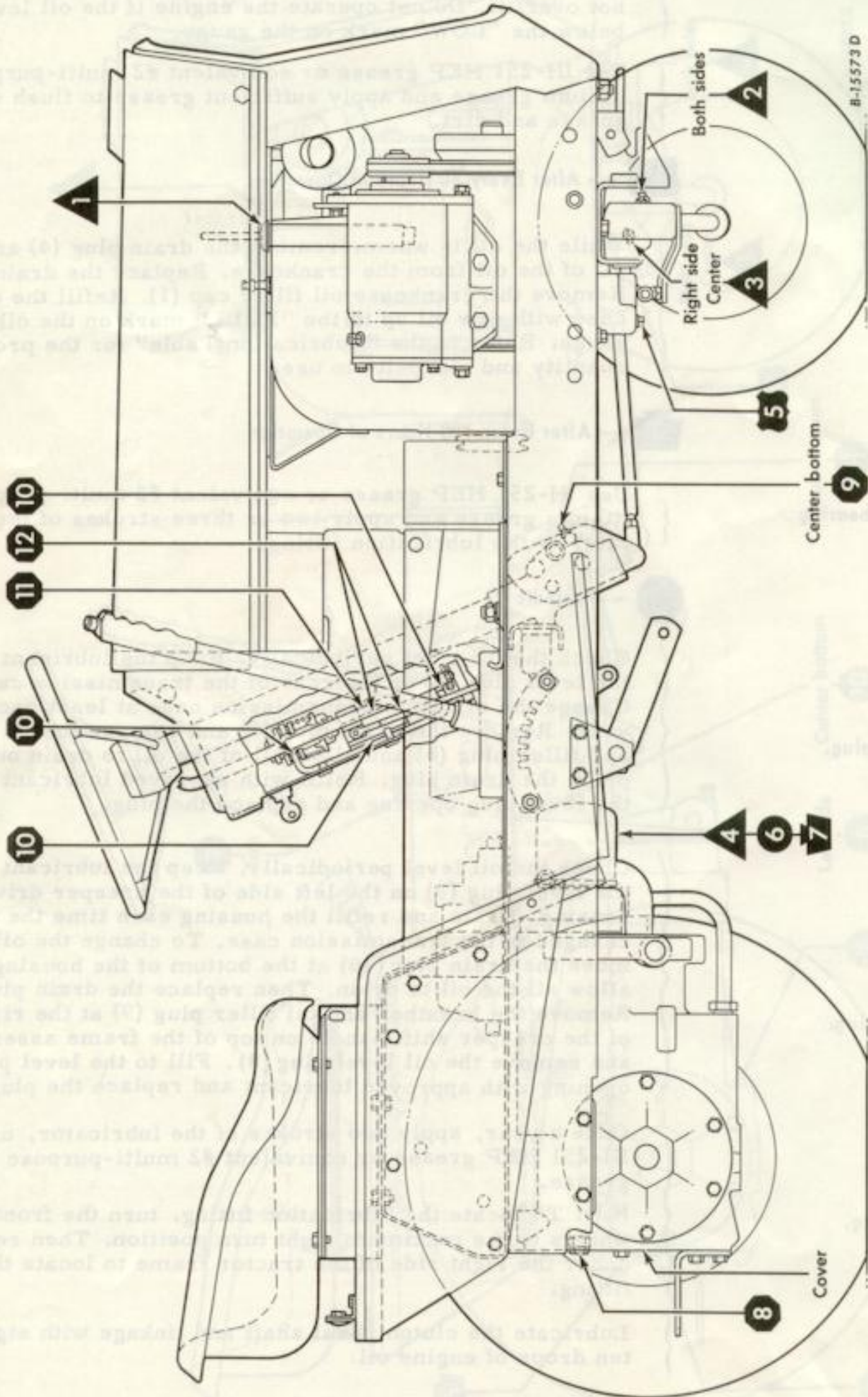

Illust. 32
Lubrication view.

LUBRICATION GUIDE

(International Cub Cadet 105 and 125 Tractors)

▲ --After Every 10 Hours of Operation

1. Oil filler cap and bayonet-type oil level gauge.

Check the oil (with the engine stopped) and add sufficient new oil to bring it to the "FULL" mark on the gauge. Do not overfill. Do not operate the engine if the oil level is below the "LOW" mark on the gauge.

2. Steering knuckles (2).
3. Front axle pivot pin.

Use IH-251 HEP grease or equivalent #2 multi-purpose lithium grease and apply sufficient grease to flush out old grease and dirt.

4. Transmission oil filter.

Note: After the first 10 hours only, remove the old filter and replace with a new filter as instructed on page 29. Change the oil filter after 50 hours and every 100 hours of operation thereafter.

■ --After Every 30 Hours of Operation

5. Engine crankcase.

While the oil is warm, remove the drain plug (5) and drain all of the oil from the crankcase. Replace the drain plug. Remove the crankcase oil filler cap (1). Refill the crankcase with new oil up to the "FULL" mark on the oil level gauge. Refer to the "Lubrication Table" for the proper quantity and viscosity to use.

● --After Every 50 Hours of Operation

6. Transmission oil filter.

Note: After the first 50 hours only, remove the old filter and replace with a new filter as instructed on page 29. Change the oil filter every 100 hours of operation thereafter.

■ --After Every 100 Hours of Operation

7. Transmission oil filter.

Change the oil filter and replace with a new filter as instructed on page 29.

● --Periodic

Transmission

8. Oil level and filler plug.

Check the oil level periodically or once a year. Keep the lubricant up to the level plug (8) on the rear of the transmission case cover.

LUBRICATION GUIDE

(International Cub Cadet 105 and 125 Tractors)

● — Periodic

9. Steering gear housing.

Once a year, apply two strokes of the lubricator, using IH-251 HEP grease or equivalent #2 multi-purpose lithium grease.

Note: To locate the lubrication fitting, turn the front wheels to the maximum right turn position. Then reach up under the right side of the tractor frame to locate the fitting.

Speed Control Linkage

- 10. Speed control rod bracket (top, center and bottom).
- 11. Speed control rod.
- 12. Speed control centering cam channel.

Once a year, apply a light coating of IH-251 HEP grease or equivalent #2 multi-purpose lithium grease, using a hand lubricator with a flexible extension. When applying the lubricant move the speed control handle from one extreme to the other for more even distribution.

Note: It may be necessary to remove the battery for convenience in reaching the lubrication points.

Miscellaneous

Lubricate the brake pedal shaft and linkage with eight or ten drops of engine oil.

SPECIFICATIONS

	International Cub Cadet 72 Tractor	International Cub Cadet 104 Tractor	International Cub Cadet 124 Tractor	International Cub Cadet, 105 and 125 Tractors
CAPACITIES (APPROXIMATE-U.S. MEASURE)				
Fuel tank	5 qt.	6-1/2 qt.	8 qt.	8 qt.
Crankcase	2-1/2 pt.	3 pt.	3 pt.	3 pt.
Transmission case	7 pt.	7 pt.	7 pt.	7 qt.
Steering gear housing	1/4 lb.	1/4 lb.	1/4 lb.	1/4 lb.
Creeper drive housing	1/2 pt.	1/2 pt.	1/2 pt.	
TRANSMISSION (THREE SPEEDS)				
Speed: 1st	2.3 mph	2.3 mph	2.3 mph	
2nd	3.9 mph	3.9 mph	3.9 mph	
3rd	6.9 mph	6.9 mph	6.9 mph	
Reverse	2.5 mph	2.5 mph	2.5 mph	
TRANSMISSION (SPEEDS)				
Speed: Forward				0 to 8 mph
Reverse				0 to 4 mph

SPECIFICATIONS

	International Cub Cadet 72 Tractor	International Cub Cadet 104 Tractor	International Cub Cadet 124 Tractor	International Cub Cadet, 105 and 125 Tractors
ENGINE				
Make and model (electric starting) . . . (manual starting) . . .	Kohler K 161S Kohler K 161T	Kohler K 241AS	Kohler K 301AS	Kohler K 301AS
Cylinders	1	1	1	1
Bore	2-7/8 in.	3-1/4 in.	3-3/8 in.	3-3/8 in.
Stroke	2-1/2 in.	2-7/8 in.	3-1/4 in.	3-1/4 in.
Displacement	16-1/4 cu. in.	23.9 cu. in.	29.1 cu. in.	29.1 cu. in.
Engine speed(governed)				
Low speed	1000 rpm	1000 rpm	1000 rpm	1000 rpm
High idle speed (no load)	3780 rpm	3800 rpm	3800 rpm	3800 rpm
Full load	3600 rpm	3600 rpm	3600 rpm	3600 rpm
Valve clearance (engine cold)006 (intake) .017 (exhaust)	.010 (intake) .020 (exhaust)	.010 (intake) .020 (exhaust)	.010 (intake) .020 (exhaust)
Ignition (electric starting) . . . (manual starting) . . .	Battery Magneto	Battery	Battery	Battery
Spark plug gap (14mm plug) (Champion J-8 or equivalent) (Champion H-10 or equivalent)025 in. gap	.025 in. gap	.025 in. gap	.025 in. gap
Breaker points020 in. gap	.020 in. gap	.020 in. gap	.020 in. gap
Timing	20 degrees before TDC	20 degrees before TDC	20 degrees before TDC	20 degrees before TDC

REAR POWER TAKE-OFF SPEED (Counterclockwise Rotation)

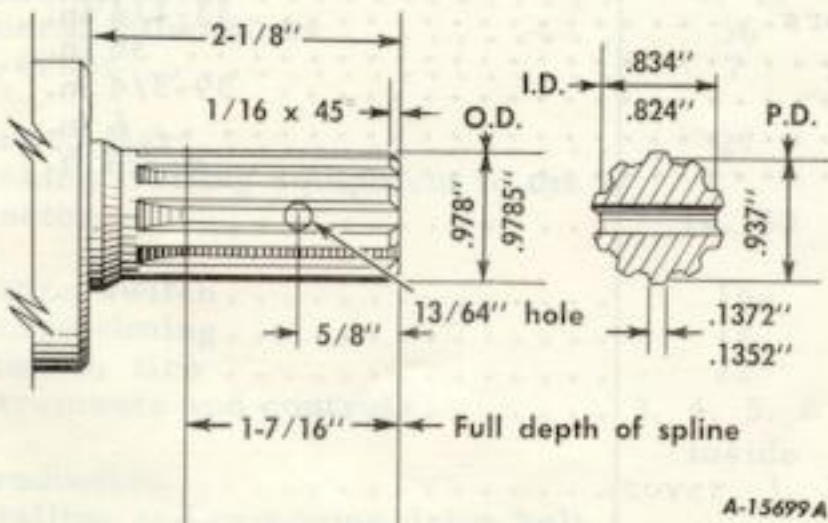

Illust. 35

Rear Power take-off shaft spline dimensions
(International Cub Cadet 72, 104 and 124 Tractors).

The power take-off shaft connection is a 15/16-inch pitch diameter, ten-tooth involute spline with a 30 degree pressure angle, machined for outside diameter fit. The dimensions are shown in Illust. 35.

Power take-off shaft governed speed 515 r.p.m.

Direction of rotation (looking at rear of tractor) counterclockwise

Center line of power take-off shaft above rear axle center line 3-1/4-in.

End of power take-off shaft in rear of rear axle center line 7-7/16-in.

SPECIFICATIONS

	International Cub Cadet 72 Tractor	International Cub Cadet 104 Tractor	International Cub Cadet 124 Tractor	International Cub Cadet, 105 and 125 Tractors
ELECTRICAL SYSTEM				
System Voltage . . .	12 volt neg. ground	12 volt neg. ground	12 volt neg. ground	12 volt neg. ground
Battery size	LU-A8Z	LU-A9Z	LU-A9Z	LU-A9Z
Motor-generator, Delco-Remy . . .	15 amp.	15 amp.	15 amp.	15 amp.
Voltage regulator, Delco-Remy . . .	2 unit	2 unit	2 unit	2 unit
Fuse (cartridge type)	AGC-10 amp.	AGC-10 amp.	AGC-10 amp.	AGC-10 amp.
Headlights - all glass, sealed beam units		<u>Lamp No.</u> 4411	<u>IH part No.</u> 373 662 R91	
Taillight		67	142 450	

FOOT BRAKE

Disc type, on transmission shaft 4-1/2 in.

CLUTCH

Double-plate, dry disc, spring loaded (Models 72, 104 and 124 Tractors) 4-1/2 in.

WHEELS AND TREAD

Front wheels, pneumatic tire size †4.80/4.00-8

Rear wheels, pneumatic tire size { Models 72, 104, and 105 Tractors †6-12
 Models 124 and 125 Tractors 23x8.50-12

Wheelbase 43 in.

Tread 27 in.

GENERAL

Length, over-all 64 in.

Width, over-all { Models 72, 104, and 105 Tractors 33-1/4 in.
 Models 124 and 125 Tractors 36 in.

Height, over-all (to top of steering wheel) 39-3/4 in.

Ground clearance 6 in.

Turning radius 6-3/4 ft.

† Other pneumatic tire sizes are available.

Specifications are subject to change without notice.

INDEX

Description	Page No.	Description	Page No.
Adjusting brake	24, 25	Lifting the hood	7
Adjusting the clutch	24	Lighting switch button	17
Adjusting the seat	10	Lights	18
Adjusting the speed control lever	25	Locking the brake	11
Adjusting the clutch (front power) take-off	15	Lubrication	28, 29
		Lubrication guide	30 to 33
		Lubrication table	29
Before operating your new tractor	7	Motor-generator	18
Brake	25	Motor-generator belt	18
Brake pedal	11	Mounting tires on the rim	23
Breaker points	17		
Carburetor	9	Operating the power take-off with the tractor standing still	14
Carburetor adjustments	9	Operating the power take-off with the tractor in motion	14
Care of tires	22	Operating the front power take-off clutch	15
Cigarette lighter	17	Operating pressure for tires	23
Cleaning the fuel strainer and sediment bowl	8	Operating the creeper drive	12
Clutch and brake	23, 24	Operating the engine	7, 8
Clutch and brake pedal	11		
Contents	3	Pneumatic tires	22, 23
Creeper shift lever	12	Preparing the tractor for each day's work	10
Creeping	28		
Driving the tractor	10 to 12	Rear power take-off	14
Dry-type air cleaner	16	Rear Tires	22
		Rear wheel weights	23
Electrical system	16 to 21	Removing the tractor from storage	26
Engine cooling and air cleaner	16		
Engine specifications	28	Safety starting switch	16
Engine oil	28	Serial numbers	Inside cover
Engine oil level	29	Spark plug	17
Engine operates irregularly or knocks	27	Speed control lever	12
Engine overheats	28	Specifications	34 to 36
Engine serial number	Inside cover	Starting the engine with electric starting	8
Extra equipment and accessories	26	Starting the engine with manual starting	8
		Starting the tractor	11, 12
Front power take-off	15	Stopping the engine	8
Front wheels	22	Stopping the tractor	11, 12
Front wheel toe-in	22	Storage battery	21
Fuel shut-off valve	8	Storing the tractor	26
Fuel system	8, 9		
Fuse	18	Taillight	18
		Terms of location	Inside cover
Gearshift lever	5, 11	Throttle lever	7
General dimensions	36	Tire chains	23
Governor	7	Tractor serial number	Inside cover
		Transmission oil filter	28
Hard to start	27	Transmission	28
Hitching trailing equipment to the tractor	12, 13	Trouble shooting	27, 28
		Turning radius	22
Ignition switch	16	Towing lever	12
Ignition timing	17		
Inflation, tire	22	View of the tractor	1, 2
Instruments and controls	3, 4, 5, 6 Inside cover	Voltage regulator	18
Introduction	cover, 1, 2	Wheels and tread	36
Installing and removing drive belt (front power-take off)	15		
Lack of power	27, 28		
Lift handle	13		

Price \$1.00

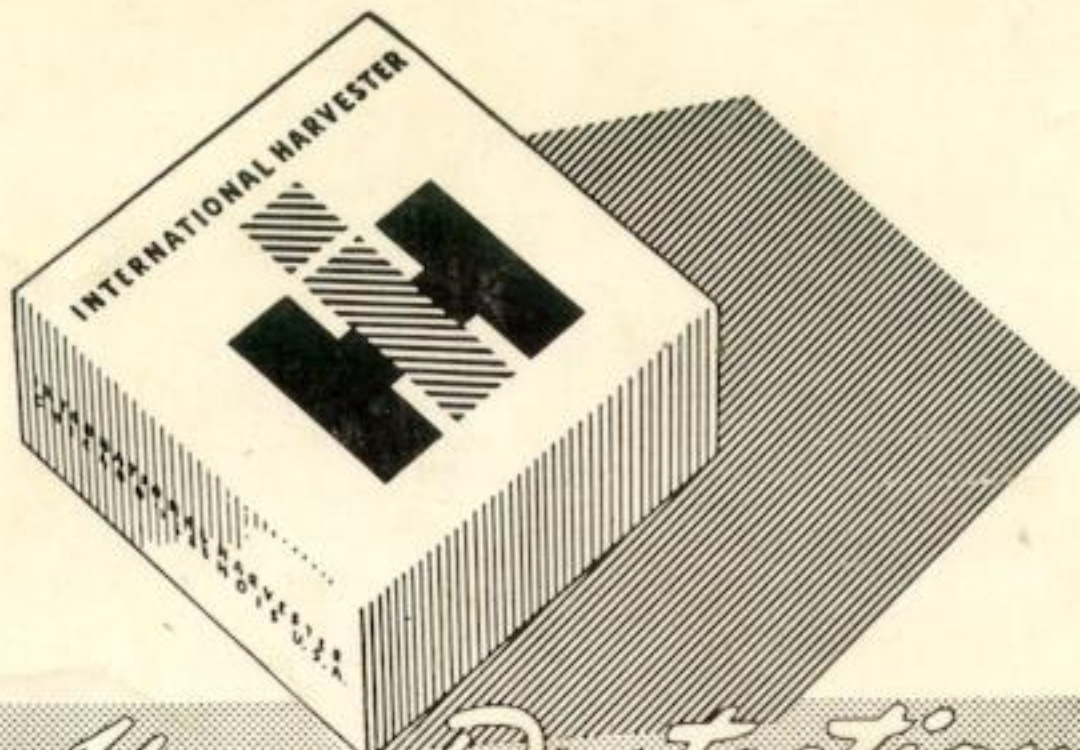

For Your Protection

Use IH Parts

TO THE OWNER—

You have just purchased one of the finest pieces of equipment available today. You can look forward to years of good service because International Harvester machines are designed better and built better to last longer.

When you need to purchase replacement parts or have your equipment serviced, we will be here, ready to serve you.

We stock genuine IH parts—the parts that are designed for your equipment, not just made for it.

We also offer you IH Blue Ribbon Service—the service that puts your equipment back to work in minimum time at an economical cost. We are here to serve you—call on us in the future.

Sincerely,

Your IH dealer

INTERNATIONAL HARVESTER COMPANY • 401 NORTH MICHIGAN AVENUE • CHICAGO, ILLINOIS 60611, U.S.A.

1 082 659 R2. Rev. 1. 5-68.

PRINTED IN UNITED STATES OF AMERICA