



## OWNER'S MANUAL

SERIES BB-56

MODEL NO. BB-562

42" GRADER BLADE

- Assembly
- Installation
- Operation
- Repair Parts

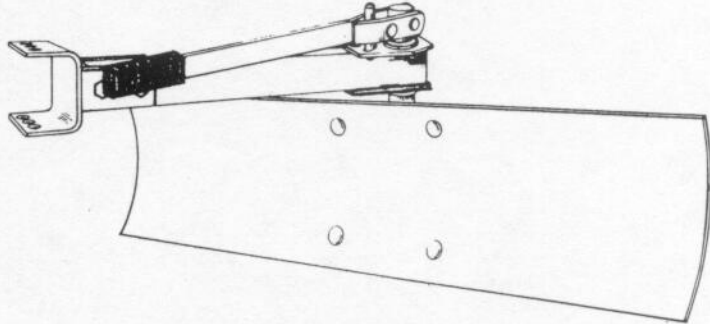

THIS IMPLEMENT FOR USE WITH GARDEN TRACTORS EQUIPPED WITH SLEEVE HITCH. ALSO, TIRE CHAINS AND WHEEL WEIGHTS ARE RECOMMENDED.

**"IMPORTANT:** THIS MANUAL CONTAINS INFORMATION FOR THE SAFETY OF PERSONS AND PROPERTY. READ IT CAREFULLY BEFORE ASSEMBLY AND OPERATION OF THE EQUIPMENT!"

### LIMITED WARRANTY

Brinly-Hardy Company warrants only to the original retail purchaser that this product will remain free of defects in workmanship and materials under normal use and service for a period of one (1) year (NOTE: ninety (90) days for commercial or rental use) commencing with the date of purchase.

Any parts found to be defective within the warranty period will be replaced, with proof of date of purchase, at Brinly Hardy Company's expense. Our obligation under this warranty is expressly limited to replacement or repair, at our option of parts which are defective in material or workmanship within thirty (30) days of receipt of the parts. This warranty does not apply to damage caused by unreasonable use, including failure to provide necessary maintenance, nor does it apply to any transportation or labor charges.

WE MAKE NO OTHER EXPRESS WARRANTY NOR IS ANYONE AUTHORIZED TO MAKE ANY ON OUR BEHALF. ANY IMPLIED OR STATUTORY WARRANTIES, INCLUDING ANY WARRANTY OF MERCHANTABILITY OR FITNESS FOR A PARTICULAR PURPOSE, ARE LIMITED TO THE DURATION OF THIS WRITTEN WARRANTY. WE SHALL NOT BE LIABLE FOR CONSEQUENTIAL OR INCIDENTAL DAMAGES OF ANY KIND.

BRINLY-HARDY COMPANY 1-800-626-5329

MADE IN U.S.A.

CONGRATULATIONS on your purchase of this Brinly Implement. It has been designed, engineered, and manufactured to give you the best possible dependability and performance.

Please read and retain this manual. The instructions will enable you to assemble and maintain your Implement properly. Always observe the "SAFETY RULES".

Should the need ever exist for repair parts, order through most any Lawn and Garden dealer, using part number and description.



## RULES FOR SAFE OPERATION

- Know controls and how to stop quickly, READ THE OWNER'S MANUAL.
- Do not allow children to operate the vehicle, do not allow adults to operate without proper instruction or without having read the owner's manual.
- Do not carry passengers. Keep children and pets a safe distance away.
- Always wear substantial footwear. Do not wear loose fitting clothing that can get caught in moving parts.
- Keep your eyes and mind on your tractor/attachment and area being covered. Do not let other interests distract you.
- Stay alert for holes in the terrain and other hidden hazards.
- Do not drive close to creeks, ditches and public highways.
- Watch out for traffic when crossing or near roadways.
- When using any attachments, don't allow anyone near the vehicle while in operation.
- Keep the vehicle and attachments in good operating condition and keep safety devices in place.
- Keep all nuts, bolts and screws tight to be sure the equipment is in safe working condition.
- The vehicle and attachments should be stopped and inspected for damage after striking a foreign object. The damage should be repaired before restarting and operating the equipment.
- See tractor equipment owner's manual for safe operation of the equipment.



### WARNING!

- Always stop the tractor and raise Blade to transport position BEFORE changing blade angle or reversing blade.
- Care should be taken not to "hang" the blade on surface projections such as corners of concrete driveways.
- NEVER allow anyone to "ride" on the rear blade.
- Lock Tractor Lift Handle DOWN when installing or removing Blade on Sleeve Hitch.



LOOK FOR THIS SYMBOL TO POINT OUT IMPORTANT SAFETY PRECAUTIONS. IT MEANS - ATTENTION! BECOME ALERT! YOUR SAFETY IS INVOLVED.

---

## CUSTOMER RESPONSIBILITIES

---

- Read and observe the "SAFETY RULES".
- Follow a regular schedule in maintaining, caring for and using your Implement.

---

## TABLE OF CONTENTS

---

WARRANTY.....	1
SAFETY RULES.....	2
CARTON CONTENTS.....	3
ASSEMBLY.....	4

ADJUSTMENTS.....	4
OPERATION.....	5
MAINTENANCE.....	5
REPAIR PARTS.....	6

# CONTENTS OF SHIPPING CARTON

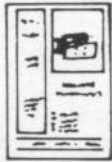

No. A L-1434  
Owner's Manual  
1 Used



No. B Z-1428-A  
Hardware Bag  
1 Used



No. C Z-1428-B  
Hardware Bag  
1 Used

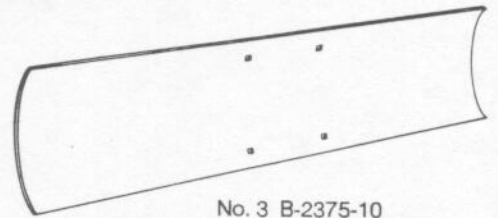

No. 3 B-2375-10  
Blade, 42"  
1 Used

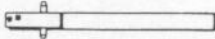

No. 4 B-2376-10  
Angling Lever  
1 Used



No. 7 B-2596-10  
Blade Mount Plate  
1 Used

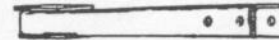

No. 10 B-4351-10  
Drawbar Assembly  
1 Used

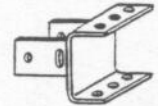

No. 9 B-4265-10  
Hitch Assembly  
1 Used

## Z-1428-A HARDWARE BAG (ACTUAL SIZE)

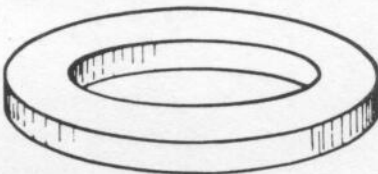

No. 1 B-811P  
Flat Washer  
1 Used



No. 14 30M1200P  
Hex Nut, 3/8"  
4 Used



No. 15 30M1600P  
1/2" Hex Nut  
4 Used



No. 2 B-1675P  
Hex Lock Nut  
3/8"  
1 Used

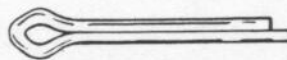

No. 20 50M0416  
Cotter Pin  
1/8" x 1"  
1 Used



No. 5 B-2578  
Shear Pin  
7/16" x 2-3/8"  
1 Used

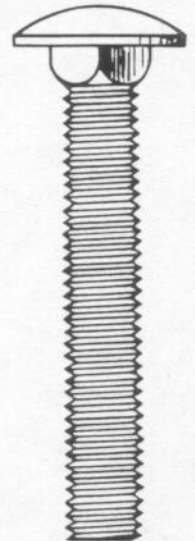

No. 13 10M1240P  
Carriage Bolt  
3/8" x 2-1/2"  
1 Used

## Z-1428-B HARDWARE BAG (ACTUAL SIZE)



No. 6 B-3717  
Handle Grip  
1 Used



No. 19 45M1717P  
1/2" Flat Washer  
2 Used

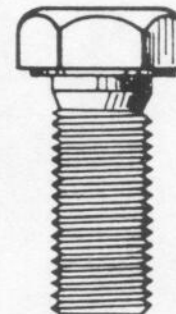

No. 11 2M1620P  
1/2" x 1-1/4" Hex Bolt  
4 Used



No. 12 10M1216P  
Carriage Bolt  
3/8" x 1"  
4 Used



No. 16 40M1200P  
Lock Washer, 3/8"  
4 Used



No. 17 45M1313P  
Flat Washer, 3/8"  
4 Used



No. 18 40M1600P  
1/2" Lock Washer  
4 Used



## ASSEMBLY

### NOTES:

- It is recommended that you carefully read this Owner's Manual before starting assembly.
- Right hand (R.H.) and Left hand (L.H.) are determined from the Operator's position while seated on the tractor.

Refer to FIG. 1

- Attach the Blade to the Blade Mount Plate using four 3/8" x 1" Carriage Bolts, 3/8" Lock Washers, 3/8" Flat Washers, and secure loosely with 3/8" Hex Nuts. DO NOT tighten these fasteners.
- Attach the Hitch Assembly to the Drawbar using four 1/2" x 1-1/4" Hex Bolts, Lock Washers and nuts. Two 1/2" Flat Washers assemble next to slots in the Hitch Assembly. Do not tighten at this time.
- Slip the Drawbar down the Blade Mount Plate Post as shown in the Illustration.
- Slip the Large Flat Washer down the post followed by the Angling Lever as shown.
- Insert the 7/16" x 2-3/8" Shear Pin through the round holes in Lever and Post.
- Insert the 1/8" x 1" Cotter Pin through the hole in the end of Shear Pin and bend legs over.
- Insert 3/8" x 2-1/2" Carriage Bolt through the remaining two holes (square) in the Angling Lever and secure with the 3/8" Hex Lock Nut.
- Tighten the Lock Nut just enough to remove any "looseness" in the Angling Lever -- it must be free to move up and down without binding.
- Slide the Handle Grip onto the end of the Angling Lever.

## ADJUSTMENTS

Refer to FIG. 2

- Attach the completed Rear Blade to the Sleeve Hitch on your Tractor, in the middle hole of Blade Hitch, using the Hitch Pins furnished with your Hitch.
- Position the Tractor (with blade) on a hard, level surface.
- Lower the Blade and check to make sure it is level, side to side, and then tighten the four 3/8" x 1" Carriage Bolts, holding the Blade to the Post.
- Place a level on top of Drawbar - move Hitch Assembly until Drawbar is level, front to back. Tighten the Four 1/2" Hex Bolts securely.
- The Stabilizer Bolts on the Hitch should be tightened against the Yoke on Drawbar to prevent any "side-sway" during operation of the Blade.
- The operating depth of the Blade needs to be set now. Make sure the Tractor Hitch is free to allow Blade to go below ground level, but still maintaining a minimum of 5" transport with Hitch raised. Refer to your Tractor and/or Sleeve Hitch Manual for any necessary adjustments.

### TOOLS REQUIRED FOR ASSEMBLY:

- 1 - 9/16" Wrench
- 2 - 3/4" Wrenches
- 1 - Pair of Pliers (Slip-joint recommended)
- 1 - Level

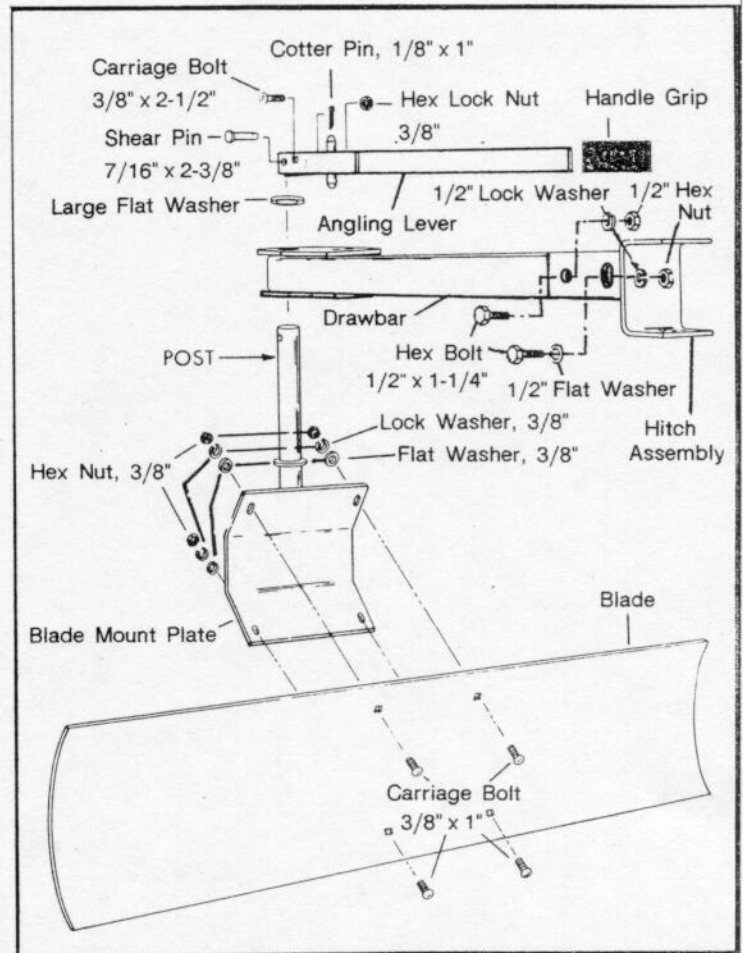

FIG. 1

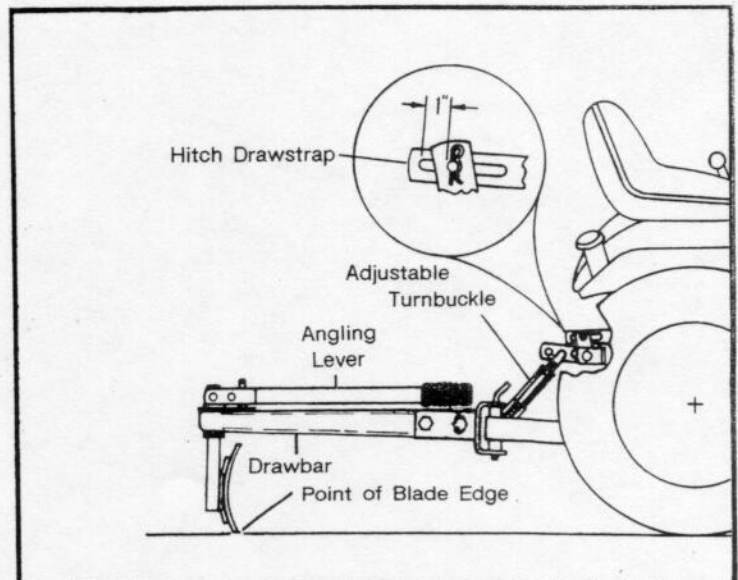

FIG. 2

---

## OPERATION

---

- Various blade angles (left and right) are obtained by lifting Lever, rotating the Blade to the desired angle, then lowering the Lever into one of the locking holes.
- To use the Blade with the Tractor in the reverse gear, raise the Lever, rotate the Blade 180 degrees and lock into the desired position.
- The Rear Blade is designed to be used in a variety of light jobs such as leveling, scraping, raking, back filling, snow removal, etc.

- The tractor speed while operating the Rear Blade should be governed by the task to be accomplished.
- While grading, do not attempt to cut excessive amounts of hard-packed material at a high rate of speed.

NOTE: Operate at a speed which allows loose material that has piled up on the face of the Blade to be deposited in low areas.

---

## MAINTENANCE

---

- After the Blade Edge has worn considerably, it should be rotated (from bottom to top) to provide a "new" edge. Remove the four 3/8" x 1" Carriage Bolts, rotate the Blade, and then reassemble the unit with the "new" edge on the surface.
- Lubricate all Pivoting points with a drop or two of 30 weight oil.

---

## NOTES

---

# 42" Grader Blade

TO ORDER PARTS:  
BRINLY HARDY COMPANY  
P.O. BOX 18  
JEFFERSONVILLE, IN.  
47131-0018

(877) 728-8224

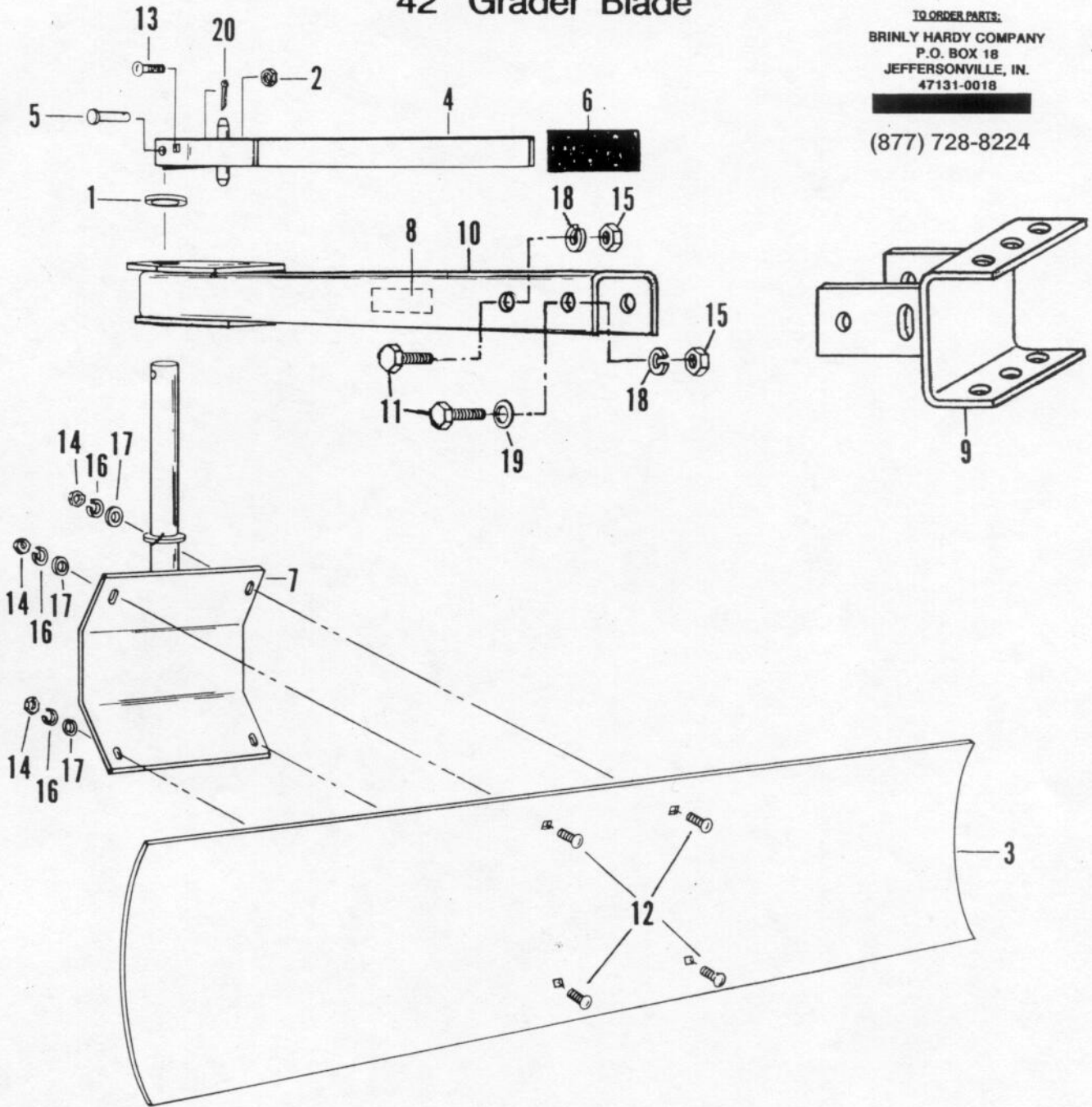

## PARTS LIST

Ref. No.	Part No.	Description	Qty.	Ref. No.	Part No.	Description	Qty.
1	B-811-P	Flat Washer (Bushing)	1	12	10M1216P	Carriage Bolt, 3/8" x 1"	4
2	B-1675P	Hex Lock Nut, 3/8"	1	13	10M1240P	Carriage Bolt, 3/8" x 2-1/2"	1
3	B-2375-10	Blade, 42"	1	14	30M1200P	Hex Nut, 3/8"	4
4	B-2376-10	Angling Lever	1	15	30M1600P	Hex Nut, 1/2"	4
5	B-2578	Shear Pin, 7/16" x 2-3/8"	1	16	40M1200P	Lock Washer, 3/8"	4
6	B-3717	Handle Grip	1	17	45M1313P	Flat washer, 3/8"	4
7	B-2596-10	Blade Mount Plate	1	18	40M1600P	Lock Washer, 1/2"	4
8	B-5925	Logo Decal	1	19	45M1717P	Flat Washer, 1/2"	4
9	B-4265-10	Hitch Assembly	1	20	50M0416P	Cotter Pin, 1/8" x 1"	1
10	B-4351-10	Drawbar	1	21	L-1434	Owner's Manual	1
11	2M1620P	Hex Bolt, 1/2" x 1-1/4"	4				



Sprayers



Brinly sprayers are designed to be easy to use, extremely accurate, and long lasting. Our in-line mounted tank design means that even the biggest tank is easy to maneuver and can fit through a garden gate. Each unit comes with a tractor-mounted on/off control.

Poly Lawn Rollers

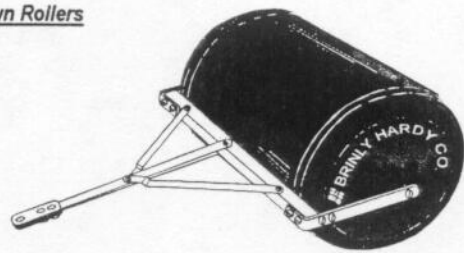

No more rust or dents with these poly lawn rollers. These units are much easier to deal with than the steel versions. They have rounded end caps that won't tear or gouge the lawn when turning. Erase the harmful effects of front heaving and moles, or pack down newly sown seed or sod.

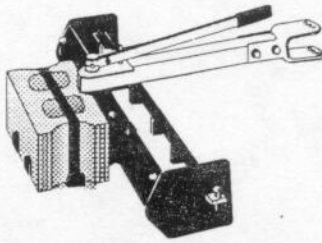

Garden Tractor Attachments

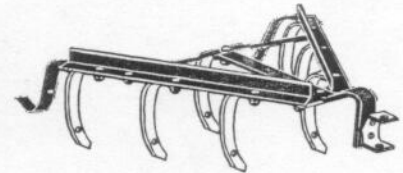
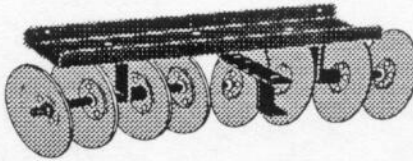

Brinly's garden tractor items offer the largest selection to turn your garden tractor into a year-round tool. We have box scrapers, blades, cultivators, disk harrows, and even a plow! Remember that a sleeve hitch is required to hook up these items to your garden tractor.

**Quality Insurance**

Dear Customer,

We are very proud of our quality and endeavor to produce each product to meet high standards. Should your purchase not meet your expectations, we have a Quality Insurance Policy.

If you purchase a product and a part is missing or defective, please inform us of the problem on the "Comments" section of the Warranty Registration Card below. Mail the card to us, or you may call us toll free at 1-800-626-5329. We will make every effort to ship a new replacement part to you within 24 hours at no charge.

Thank you,

President  
Brinly-Hardy Company

**Customer Service**

**(877) 728-8224**

**WARRANTY REGISTRATION CARD**

To register your new product for warranty, please complete and return this card.

Name: \_\_\_\_\_ Phone: \_\_\_\_\_

Address: \_\_\_\_\_

City: \_\_\_\_\_ State: \_\_\_\_\_ Zip: \_\_\_\_\_ Country: \_\_\_\_\_

Product Purchased: \_\_\_\_\_ Model No.: \_\_\_\_\_

Packing No. (On Carton): \_\_\_\_\_

Where Purchased: \_\_\_\_\_ Date Purchased: \_\_\_\_\_

Type of Tractor/Rider Owned? Make: \_\_\_\_\_ Model: \_\_\_\_\_ HP: \_\_\_\_\_

Size of Lawn?  1/4 to 1/2 acre  1/2 to 1 acre  1 to 5 acres  over 5 acres

Do you garden?  Yes  No  Use a tractor?  Use a tiller?

Your occupation: \_\_\_\_\_

**YOUR COMMENTS WILL BE APPRECIATED:** \_\_\_\_\_

\_\_\_\_\_  
\_\_\_\_\_  
\_\_\_\_\_  
\_\_\_\_\_

**Warranty Registration Card**

Please complete the Warranty Registration Card, place in an envelope and mail to us so that we will have a record of your purchase and your comments.



BRINLY HARDY COMPANY  
P.O. BOX 18  
JEFFERSONVILLE, IN.  
47131-0018

# CARING FOR THE QUALITY OF YOUR LAWN

with quality products from  
**BRINLY-HARDY COMPANY, JEFFERSONVILLE, IN**

## Our Quality Products

### Spike Aerators

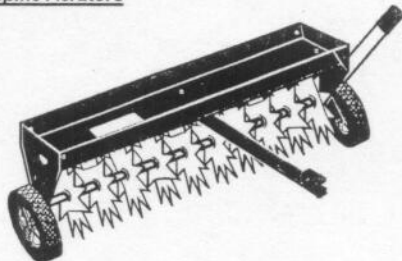

Our Spiker Aerators allow seed, fertilizer, air, and water to reach the lawn's root system, where they do the most good. This means fewer chemical applications and less frequent watering.

### Plug Aerators

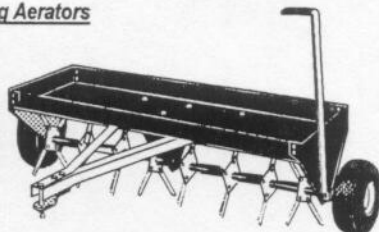

Our Plug-type Aerators are designed for the lawn care enthusiast who demands the ultimate in turf aeration! It actually pulls "plugs" of soil to relieve soil compaction and deposits them on top of the lawn where they're quickly broken down. You, too, can have a healthy looking lawn, once only affordable to golf courses!

### TO ORDER PARTS:

Brinly-Hardy Company  
P.O. Box 18  
Jeffersonville, IN 47131-0018

**(877) 728-8224**

### Aerator Spreaders

You can actually handle two jobs at once with our Aerator-Spreader! This natural combination allows the 30" Aerator to perforate the soil, and the spreader immediately follows with seed, lime, or fertilizer, putting it INTO the ground so it can't be washed away!

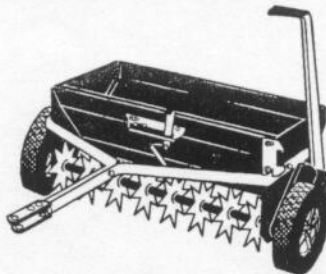

### Broadcast Spreaders

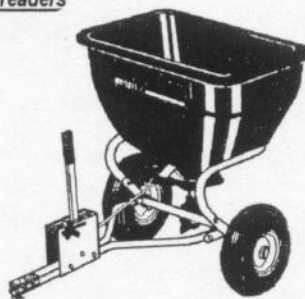

Our Brinly Spreaders handle everything from seed to ice-melters. Equipped with AutoFlow™, the material flow stops and starts when the rider does...no need to worry about "burns" or "streaks" on the lawn. Our gears are fully enclosed, so they'll last and last!

Our larger 2.5 and 3.5 cu. ft. Spreaders offer a unique, Directional Spread Pattern Control that lets you CHOOSE your spread pattern; adjust it to spread to either side or to center. Also, a clear, vinyl cover is included to protect materials from moisture.

## About the Company

For generations, Brinly-Hardy has been serving the growing needs of farmers, gardeners, lawn professionals, and homeowners. Our first plow was introduced in 1839, and ever since, we have been forging a name in the production of quality-crafted farm, lawn, turf, and garden tools. It's a proud heritage, one you can trust in caring for your lawn.

### Dethatchers

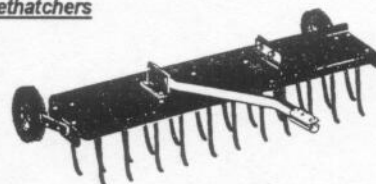

If left alone, matted layers of thatch and large grass clippings can form on your lawn which prevents air circulation and breeds disease. Our patented design Dethatcher with spring steel tines gently comb thatch and clippings to the surface where they can be re-mulched, collected, or left exposed to the elements to break down.

### Utility Carts



Our Dumping Utility Carts have a patented, rounded corner design which prevents soil, gravel, mulch, sand, etc. from getting trapped along the edges (where they can cause rust), and the bracketless, removable tail-gate has NO obstructions to catch material when dumping. These Utility Carts are built to last with our solid steel axles, heavy steel beds, and our state-of-the-art powder coated paint finish.

CUT HERE

**BRINLY-HARDY COMPANY**  
**P.O. BOX 18**  
**JEFFERSONVILLE, IN 47131-0018**

**(877) 728-8224**

website address: [www.brinly.com](http://www.brinly.com)

e-mail address: [brinly@brinly.com](mailto:brinly@brinly.com)

### Sweepers

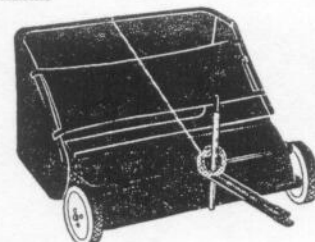

A Brinly-Hardy Sweeper is sure to make your outside chores much easier! Forget the brooms and rakes, you can quickly sweep up grass clippings, leaves, and even debris from the pavement and quickly dump them into compost bins or bags. The spring-loaded Compost Clip makes it a snap!

For even more versatility, attach our new Dethatcher Kit to either our 30" or 36" Sweeper, and tackle two jobs at once!

These sweepers are built for all seasons and will last for years and years.